

Agilent E4991A RF Impedance/Material Analyzer

Data Sheet



Agilent Technologies

Definitions

All specifications apply over a 5 °C to 40 °C range (unless otherwise stated) and 30 minutes after the instrument has been turned on.

Specification (spec.)

Warranted performance. Specifications include guardbands to account for the expected statistical performance distribution, measurement uncertainties, and changes in performance due to environmental conditions.

Supplemental information is intended to provide information useful in applying the instrument, but that is not covered by the product warranty. The information is denoted as typical, or nominal.

Typical (typ.)

Expected performance of an average unit which does not include guardbands. It is not covered by the product warranty.

Nominal (nom.)

A general, descriptive term that does not imply a level of performance. It is not covered by the product warranty.

Measurement Parameters and Range

Measurement parameters

Impedance parameters:

$|Z|$, $|Y|$, L_s , L_p , C_s , C_p , $R_s(R)$, R_p , X , G , B , D , Q , θ_z , θ_y , $|\Gamma|$, Γ_x , Γ_y , θ_γ

Material parameters (option E4991A-002):

(see "Option E4991A-002 material measurement (typical)" on page 17)

Permittivity parameters: $|\epsilon_r|$, ϵ_r' , ϵ_r'' , $\tan\delta$

Permeability parameters: $|\mu_r|$, μ_r' , μ_r'' , $\tan\delta$

Measurement range

Measurement range ($|Z|$):

130 m Ω to 20 k Ω .

(Frequency= 1 MHz,

Point averaging factor ≥ 8 ,

Oscillator level= -3 dBm; = -13 dBm; or = -23 dBm,

Measurement accuracy $\leq \pm 10\%$,

Calibration is performed within 23 °C ± 5 °C,

Measurement is performed within ± 5 °C of calibration temperature)

Source Characteristics

Frequency

Range:

1 MHz to 3 GHz

Resolution:

1 mHz

Accuracy:

without Option E4991A-1D5:

±10 ppm (23 °C ±5 °C)

±20 ppm (5 °C to 40 °C)

with Option E4991A-1D5:

±1 ppm (5 °C to 40 °C)

Stability:

with Option E4991A-1D5:

±0.5 ppm/year (5 °C to 40 °C)

Oscillator level

Range:

Power (when 50 Ω load is connected to test port):

–40 dBm to 1 dBm (frequency ≤ 1 GHz)

–40 dBm to 0 dBm (frequency > 1 GHz¹)

Current (when short is connected to test port):

0.0894 mArms to 10 mArms (frequency ≤ 1 GHz)

0.0894 mArms to 8.94 mArms (frequency > 1 GHz¹)

Voltage (when open is connected to test port):

4.47 mVrms to 502 mVrms (frequency ≤ 1 GHz)

4.47 mVrms to 447 mVrms (frequency > 1 GHz¹)

Resolution:

0.1 dB²

Accuracy:

(Power, when 50 Ω load is connected to test port)

Frequency ≤ 1 GHz:

±2 dB (23 °C ±5 °C)

±4 dB (5 °C to 40 °C)

Frequency > 1 GHz:

±3 dB (23 °C ±5 °C)

±5 dB (5 °C to 40 °C)

with Option E4991A-010:

Frequency ≤ 1 GHz

±3.5 dB (23 °C ±5 °C)

±5.5 dB (5 °C to 40 °C)

Frequency > 1 GHz

±5.6 dB (23 °C ±5 °C)

±7.6 dB (5 °C to 40 °C)

Output impedance

Output impedance:

50 Ω (nominal)

DC Bias (Option E4991A-001)

DC voltage bias

Range:

0 to ±40 V

Resolution:

1 mV

Accuracy:

±{0.1% + 6 mV + (Idc[mA] x 20 Ω)[mV]}
(23 °C ±5 °C)

±{0.2% + 12 mV + (Idc[mA] x 40 Ω)[mV]}
(5 °C to 40 °C)

DC current bias

Range:

100 μA to 50 mA, –100 μA to –50 mA

Resolution:

10 μA

Accuracy:

±{0.2% + 20 μA + (Vdc[V]/10 kΩ)[mA]}
(23 °C ±5 °C)

±{0.4% + 40 μA + (Vdc[V]/5 kΩ)[mA]}
(5 °C to 40 °C)

DC bias monitor

Monitor parameters:

Voltage and current

Voltage monitor accuracy:

±{0.5% + 15 mV + (Idc[mA] x 2 Ω)[mV]}
(23 °C ±5 °C, typical)

±{1.0% + 30 mV + (Idc[mA] x 4 Ω)[mV]}
(5 °C to 40 °C, typical)

Current monitor accuracy:

±{0.5% + 30 μA + (Vdc[V] / 40 kΩ)[mA]}
(23 °C ±5 °C, typical)

±{1.0% + 60 μA + (Vdc[V] / 20 kΩ)[mA]}
(5 °C to 40 °C, typical)

1. It is possible to set more than 0 dBm (447 mV, 8.94 mA) oscillator level at frequency > 1 GHz. However, the characteristics at this setting are not guaranteed.

2. When the unit is set at mV or mA, the entered value is rounded to 0.1 dB resolution.

Probe Station Connection Kit (Option E4991A-010)

Oscillator level

Power accuracy:

Frequency ≤ 1 GHz:
 ± 5.5 dB (5 °C to 40 °C)
 Frequency > 1 GHz:
 ± 7.6 dB (5 °C to 40 °C)

Sweep Characteristics

Sweep conditions

Sweep parameters:

Frequency, oscillator level (power, voltage, current), DC bias voltage, DC bias current

Sweep range setup:

Start/stop or center/span

Sweep types:

Frequency sweep: linear, log, segment
 Other parameters sweep: linear, log

Sweep mode:

Continuous, single

Sweep directions:

Oscillator level, DC bias (voltage and current): up sweep, down sweep
 Other parameters sweep: up sweep

Number of measurement points:

2 to 801

Delay time:

Types: point delay, sweep delay, segment delay
 Range: 0 to 30 sec
 Resolution: 1 msec

Segment sweep

Available setup parameters for each segment:

Sweep frequency range, number of measurement points, point averaging factor, oscillator level (power, voltage, or current), DC bias (voltage or current), DC bias limit (current limit for voltage bias, voltage limit for current bias)

Number of segments:

1 to 16

Sweep span types:

Frequency base or order base

Measurement Accuracy

Conditions for defining accuracy

Temperature:

23 °C ± 5 °C

Accuracy-specified plane:

7-mm connector of test head

Accuracy defined measurement points:

Same points at which the calibration is done.

Accuracy when open/short/load calibration is performed

$|Z|, |Y|:$ $\pm(E_a + E_b)$ [%]
 (see Figures 1 through 4 for examples of calculated accuracy)

$\theta:$ $\pm \frac{(E_a + E_b)}{100}$ [rad]

L, C, X, B: $\pm (E_a + E_b) \times \sqrt{(1 + D_x^2)}$ [%]

R, G: $\pm (E_a + E_b) \times \sqrt{(1 + Q_x^2)}$ [%]

D:
 at $\left| D_x \tan \left(\frac{E_a + E_b}{100} \right) \right| < 1$ $\pm \frac{(1 + D_x^2) \tan \left(\frac{E_a + E_b}{100} \right)}{1 \mp D_x \tan \left(\frac{E_a + E_b}{100} \right)}$

at $D_x \leq 0.1$ $\pm \frac{E_a + E_b}{100}$

Q:
 at $\left| Q_x \tan \left(\frac{E_a + E_b}{100} \right) \right| < 1$ $\pm \frac{(1 + Q_x^2) \tan \left(\frac{E_a + E_b}{100} \right)}{1 \mp Q_x \tan \left(\frac{E_a + E_b}{100} \right)}$

at $\frac{10}{E_a + E_b} \geq Q_x \geq 10$ $\pm Q_x^2 \frac{E_a + E_b}{100}$

Accuracy when open/short/load/low-loss capacitor calibration is performed

$$|Z|, |Y|: \quad \pm(E_a + E_b) [\%]$$

$$\theta: \quad \pm \frac{E_c}{100} [\text{rad}]$$

$$\mathbf{L, C, X, B}: \quad \pm \sqrt{(E_a + E_b)^2 + (E_c D_x)^2} [\%]$$

$$\mathbf{R, G}: \quad \pm \sqrt{(E_a + E_b)^2 + (E_c Q_x)^2} [\%]$$

$$\mathbf{D}: \quad \text{at } \left| D_x \tan \left(\frac{E_c}{100} \right) \right| < 1 \pm \frac{(1 + D_x^2) \tan \left(\frac{E_c}{100} \right)}{1 \mp D_x \tan \left(\frac{E_c}{100} \right)}$$

$$\text{at } D_x \leq 0.1 \quad \pm \frac{E_c}{100}$$

$$\mathbf{Q}: \quad \text{at } \left| Q_x \tan \left(\frac{E_c}{100} \right) \right| < 1 \pm \frac{(1 + Q_x^2) \tan \left(\frac{E_c}{100} \right)}{1 \mp Q_x \tan \left(\frac{E_c}{100} \right)}$$

$$\text{at } \frac{10}{E_c} \geq Q_x \geq 10 \quad \pm Q_x^2 \frac{E_c}{100}$$

(See Figure 5)

Definition of each parameter

D_x = Measurement value of D

Q_x = Measurement value of Q

E_a = (Within ± 5 °C from the calibration temperature. Measurement accuracy applies when the calibration is performed at 23 °C ± 5 °C. When the calibration is performed beyond 23 °C ± 5 °C, measurement error doubles.)

at oscillator level ≥ -33 dBm:

$$\pm 0.65 [\%] \quad (1 \text{ MHz} \leq \text{Frequency} \leq 100 \text{ MHz})$$

$$\pm 0.8 [\%] \quad (100 \text{ MHz} < \text{Frequency} \leq 500 \text{ MHz})$$

$$\pm 1.2 [\%] \quad (500 \text{ MHz} < \text{Frequency} \leq 1 \text{ GHz})$$

$$\pm 2.5 [\%] \quad (1 \text{ GHz} < \text{Frequency} \leq 1.8 \text{ GHz})$$

$$\pm 5 [\%] \quad (1.8 \text{ GHz} < \text{Frequency} \leq 3 \text{ GHz})$$

at Oscillator level < -33 dBm:

$$\pm 1 [\%] \quad (1 \text{ MHz} \leq \text{Frequency} \leq 100 \text{ MHz})$$

$$\pm 1.2 [\%] \quad (100 \text{ MHz} < \text{Frequency} \leq 500 \text{ MHz})$$

$$\pm 1.2 [\%] \quad (500 \text{ MHz} < \text{Frequency} \leq 1 \text{ GHz})$$

$$\pm 2.5 [\%] \quad (1 \text{ GHz} < \text{Frequency} \leq 1.8 \text{ GHz})$$

$$\pm 5 [\%] \quad (1.8 \text{ GHz} < \text{Frequency} \leq 3 \text{ GHz})$$

$$\mathbf{E_b} = \pm \left[\frac{Z_s}{|Z_x|} + Y_o \cdot |Z_x| \right] \times 100 [\%]$$

($|Z_x|$: measurement value of $|Z|$)

$$\mathbf{E_c} = \pm \left[0.06 + \frac{0.08 \times F}{1000} \right] [\%]$$

(F: frequency [MHz], typical)

Z_s = (Within ± 5 °C from the calibration temperature. Measurement accuracy applies when the calibration is performed at 23 °C ± 5 °C. When the calibration is performed beyond 23 °C ± 5 °C, the measurement accuracy decreases to half that described.

F: frequency [MHz].)

at oscillator level = -3 dBm, -13 dBm, or -23 dBm:

$$\pm (13 + 0.5 \times F) [\text{m}\Omega] \quad (\text{averaging factor} \geq 8)$$

$$\pm (25 + 0.5 \times F) [\text{m}\Omega] \quad (\text{averaging factor} \leq 7)$$

at oscillator level ≥ -33 dBm

$$\pm (25 + 0.5 \times F) [\text{m}\Omega] \quad (\text{averaging factor} \geq 8)$$

$$\pm (50 + 0.5 \times F) [\text{m}\Omega] \quad (\text{averaging factor} \leq 7)$$

at oscillator level < -33 dBm

$$\pm (50 + 0.5 \times F) [\text{m}\Omega] \quad (\text{averaging factor} \geq 8)$$

$$\pm (100 + 0.5 \times F) [\text{m}\Omega] \quad (\text{averaging factor} \leq 7)$$

Y_o = (Within ± 5 °C from the calibration temperature. Measurement accuracy applies when the calibration is performed at 23 °C ± 5 °C. When the calibration is performed beyond 23 °C ± 5 °C, the measurement accuracy decreases to half that described.

F: frequency [MHz].)

at oscillator level = -3 dBm, -13 dBm, -23 dBm:

$$\pm (5 + 0.1 \times F) [\mu\text{S}] \quad (\text{averaging factor} \geq 8)$$

$$\pm (10 + 0.1 \times F) [\mu\text{S}] \quad (\text{averaging factor} \leq 7)$$

at oscillator level ≥ -33 dBm:

$$\pm (10 + 0.1 \times F) [\mu\text{S}] \quad (\text{averaging factor} \geq 8)$$

$$\pm (30 + 0.1 \times F) [\mu\text{S}] \quad (\text{averaging factor} \leq 7)$$

at oscillator level < -33 dBm

$$\pm (20 + 0.1 \times F) [\mu\text{S}] \quad (\text{averaging factor} \geq 8)$$

$$\pm (60 + 0.1 \times F) [\mu\text{S}] \quad (\text{averaging factor} \leq 7)$$

Measurement Accuracy

(continued)

Examples of calculated impedance measurement accuracy

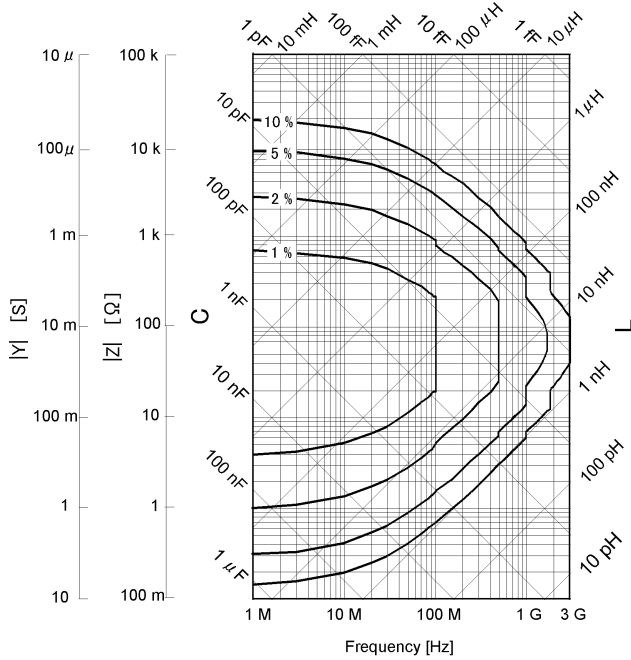

Figure 1. $|Z|$, $|Y|$ Measurement accuracy when open/short/load calibration is performed. Oscillator level = -23 dBm, -13 dBm, -3 dBm. Point averaging factor ≥ 8 within ± 5 °C from the calibration temperature.

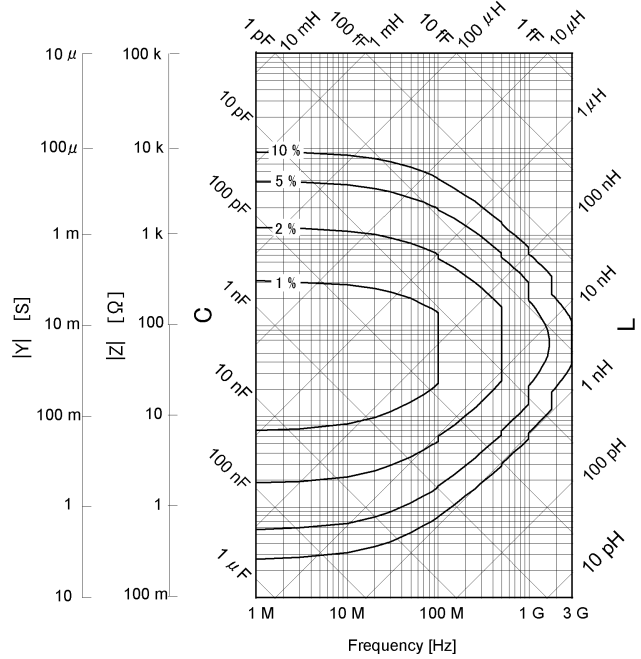

Figure 2. $|Z|$, $|Y|$ Measurement accuracy when open/short/load calibration is performed. Oscillator level ≥ -33 dBm. Point averaging factor ≥ 8 within ± 5 °C from the calibration temperature.

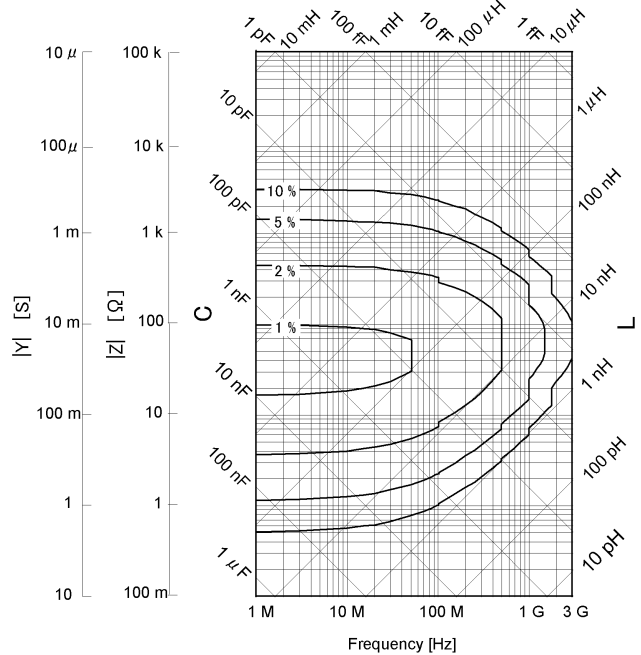

Figure 3. $|Z|$, $|Y|$ Measurement accuracy when open/short/load calibration is performed. Oscillator level ≥ -33 dBm. Point averaging factor ≤ 7 within ± 5 °C from the calibration temperature.

Measurement Support Functions

Error correction

Available calibration and compensation

Open/short/load calibration:

Connect open, short, and load standards to the desired reference plane and measure each kind of calibration data. The reference plane is called the calibration reference plane.

Low-loss capacitor calibration:

Connect the dedicated standard (low-loss capacitor) to the calibration reference plane and measure the calibration data.

Port extension compensation (fixture selection):

When a device is connected to a terminal that is extended from the calibration reference plane, set the electrical length between the calibration reference plane and the device contact. Select the model number of the registered test fixtures in the E4991A's setup toolbar or enter the electrical length for the user's test fixture.

Open/short compensation:

When a device is connected to a terminal that is extended from the calibration reference plane, make open and/or short states at the device contact and measure each kind of compensation data.

Calibration/compensation data measurement point

User-defined point mode:

Obtain calibration/compensation data at the same frequency and power points as used in actual device measurement, which are determined by the sweep setups. Each set of calibration/compensation data is applied to each measurement at the same point. If measurement points (frequency and/or power) are changed by altering the sweep setups, calibration/compensation data become invalid and calibration or compensation data acquisition is again required.

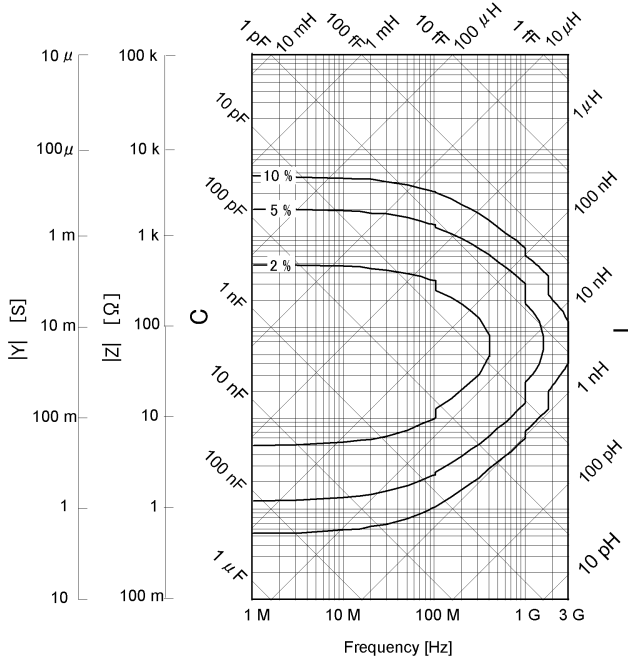

Figure 4. $|Z|$, $|Y|$ Measurement accuracy when open/short/load calibration is performed. Oscillator level < -33 dBm within ± 5 °C from the calibration temperature.

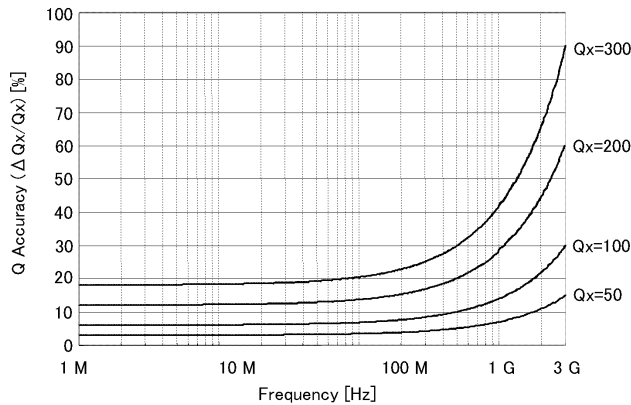

Figure 5. Q Measurement accuracy when open/short/load/low-loss capacitor calibration is performed (typical).

Measurement Support Functions *(continued)*

Fixed frequency and fixed power point mode:

Obtain calibration/compensation data at fixed frequency and power points covering the entire frequency and power range of the E4991A. In device measurement, calibration or compensation is applied to each measurement point by using interpolation. Even if the measurement points (frequency and/or power) are changed by altering the sweep setups, you don't need to retake the calibration or compensation data.

Fixed frequency and user-defined power point mode:

Obtain calibration/compensation data at fixed frequency points covering the entire frequency range of the E4991A and at the same power points as used in actual device measurement which are determined by the sweep setups.

Only if the power points are changed, calibration/compensation data become invalid and calibration or compensation data acquisition is again required.

Trigger

Trigger mode:

Internal, external (external trigger input connector), bus (GPIB), manual (front key)

Averaging

Types:

Sweep-to-sweep averaging, point averaging

Setting range:

Sweep-to-sweep averaging: 1 to 999 (integer)

Point averaging: 1 to 100 (integer)

Display

LCD display :

Type/size: color LCD, 8.4 inch (21.3 cm)

Resolution: 640 (horizontal) × 480 (vertical)

Number of traces:

Data trace: 3 scalar traces + 2 complex traces (maximum)

Memory trace: 3 scalar traces + 2 complex traces (maximum)

Trace data math:

Data – memory, data/memory (for complex parameters), delta% (for scalar parameters), offset

Format:

For scalar parameters: linear Y-axis, log Y-axis

For complex parameters: Z , Y : polar, complex; Γ : polar, complex, Smith, admittance

Other display functions:

Split/overlay display (for scalar parameters), phase expansion

Marker

Number of markers:

Main marker: one for each trace (marker 1)

Sub marker: seven for each trace (marker 2 to marker 8)

Reference marker: one for each trace (marker R)

Marker search:

Search type: maximum, minimum, target, peak

Search track: performs search with each sweep

Other functions:

Marker continuous mode, marker coupled mode, marker list, marker statistics

Equivalent circuit analysis**Circuit models:**

3-component model (4 models),

4-component model (1 model)

Analysis types:

Equivalent circuit parameters calculation, frequency characteristics simulation

Limit marker test**Number of markers for limit test:**

9 (marker R, marker 1 to 8)

Setup parameters for each marker:

Stimulus value, upper limit, and lower limit

Mass storage**Built-in flexible disk drive:**

3.5 inch, 720 KByte or 1.44 MByte, DOS format

Hard disk drive:

2 GByte (minimum)

Stored data:

State (binary), measurement data (binary, ASCII or CITI file), display graphics (bmp, jpg), VBA program (binary)

Interface

 GPIB**Standard conformity:**

IEEE 488.1-1987, IEEE 488.2-1987

Available functions (function code)³:

SH1, AH1, T6, TE0, L4, LE0, SR1, RL0, PP0, DT1, DC1, C0, E2

Numerical data transfer format:

ASCII

Protocol:

IEEE 488.2-1987

Printer parallel port**Interface standard:**

IEEE 1284 Centronics

Connector type:

25-pin D-sub connector, female

LAN interface**Standard conformity:**

10 Base-T or 100 Base-TX (automatically switched), Ethertwist, RJ45 connector

Protocol:

TCP/IP

Functions:

FTP

3. Refer to the standard for the meaning of each function code.

Measurement Terminal (At Test Head)

Connector type:
7-mm connector

Rear panel connectors

External reference signal input connector

Frequency:
10 MHz \pm 10 ppm (typical)

Level:
0 dBm to +6 dBm (typical)

Input impedance:
50 Ω (nominal)

Connector type:
BNC, female

Internal reference signal output connector

Frequency:
10 MHz (nominal)

Accuracy of frequency:
Same as frequency accuracy described in
“*Frequency*” on page 3

Level:
+2 dBm (nominal)

Output impedance:
50 Ω (nominal)

Connector type:
BNC, female

High stability frequency reference output connector (Option E4991A-1D5)

Frequency:
10 MHz (nominal)

Accuracy of frequency:
Same as frequency accuracy described in
“*Frequency*” on page 3

Level:
+2 dBm (nominal)

Output impedance:
50 Ω (nominal)

Connector type:
BNC, female

External trigger input connector

Level:

LOW threshold voltage: 0.5 V
HIGH threshold voltage: 2.1 V
Input level range: 0 V to +5 V

Pulse width (T_p):

$\geq 2 \mu\text{sec}$ (typical). See Figure 6 for definition of T_p .

Polarity:

Positive or negative (selective)

Connector type:

BNC, female

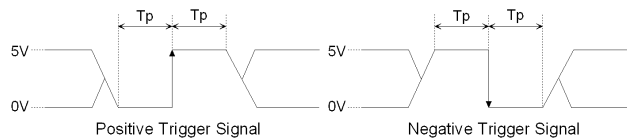

Figure 6. Definition of pulse width (T_p)

General Characteristics

Environment conditions

Operating condition

Temperature:

5 °C to 40 °C

Humidity:

(at wet bulb temperature ≤ 29 °C,
without condensation)

Flexible disk drive non-operating condition:

15% to 90% RH

Flexible disk drive operating condition:

20% to 80% RH

Altitude:

0 m to 2,000 m (0 feet to 6,561 feet)

Vibration:

0.5 G maximum, 5 Hz to 500 Hz

Warm-up time:

30 minutes

Non-operating storage condition

Temperature:

-20 °C to +60 °C

Humidity:

(at wet bulb temperature ≤ 45 °C,
without condensation)

15% to 90% RH

Altitude:

0 m to 4,572 m (0 feet to 15,000 feet)

Vibration:

1 G maximum, 5 Hz to 500 Hz

General Characteristics

(continued)

Other specifications

EMC

European Council Directive 89/336/EEC

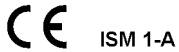

IEC 61326-1:1997+A1

CISPR 11:1990 / EN 55011:1991 Group 1, Class A

IEC 61000-4-2:1995 / EN 61000-4-2:1995

4 kV CD / 4 kV AD

IEC 61000-4-3:1995 / EN 61000-4-3:1996

3 V/m, 80-1000 MHz, 80% AM

IEC 61000-4-4:1995 / EN 61000-4-4:1995

1 kV power / 0.5 kV Signal

IEC 61000-4-5:1995 / EN 61000-4-5:1995

0.5 kV Normal / 1 kV Common

IEC 61000-4-6:1996 / EN 61000-4-6:1996

3 V, 0.15-80 MHz, 80% AM

IEC 61000-4-11:1994 / EN 61000-4-11:1994

100% 1cycle

Note: When tested at 3 V/m according to EN 61000-4-3:1996, the measurement accuracy will be within specifications over the full immunity test frequency range of 80 MHz to 1000 MHz except when the analyzer frequency is identical to the transmitted interference signal test frequency.



AS/NZS 2064.1/2 Group 1, Class A

Safety



European Council Directive 73/23/EEC

IEC 61010-1:1990+A1+A2 / EN 61010-1:1993+A2

INSTALLATION CATEGORY II, POLLUTION

DEGREE 2

INDOOR USE

IEC60825-1:1994 CLASS 1 LED PRODUCT



CAN/CSA C22.2 No. 1010.1-92

Power requirements

90 V to 132 V, or 198 V to 264 V (automatically switched), 47 Hz to 63 Hz, 350 VA maximum

Weight

Main unit: 17 kg (nominal)

Test head: 1 kg (nominal)

Dimensions

Main unit: See Figure 7 through Figure 9

Test head: See Figure 10

Option E4991A-007 test head dimensions: See Figure 11

Option E4991A-010 test head dimensions: See Figure 12

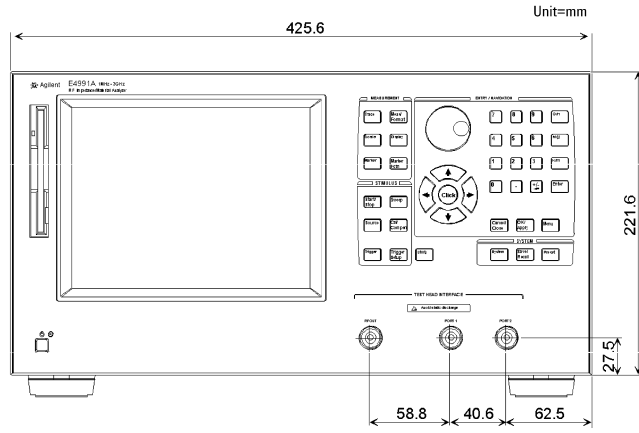

**Figure 7. Main unit dimensions
(front view, in millimeters, nominal)**

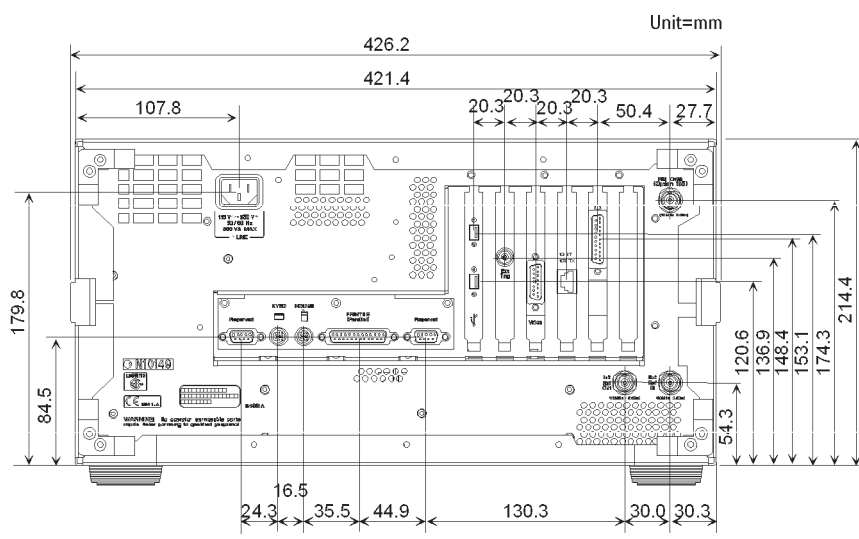

**Figure 8. Main unit dimensions
(rear view, in millimeters, nominal)**

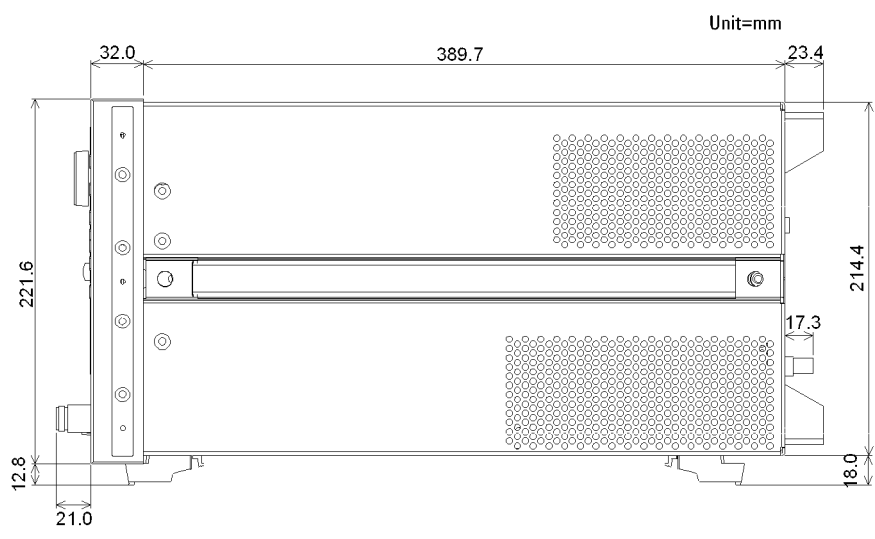

**Figure 9. Main unit dimensions
(side view, in millimeters, nominal)**

General Characteristics *(continued)*

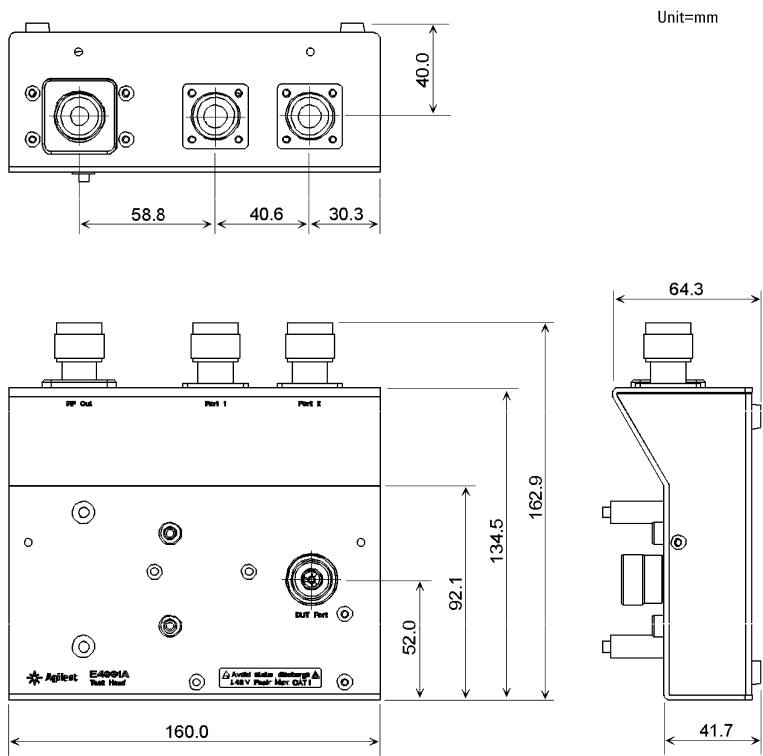

Figure 10. Test head dimensions (in millimeters, nominal)

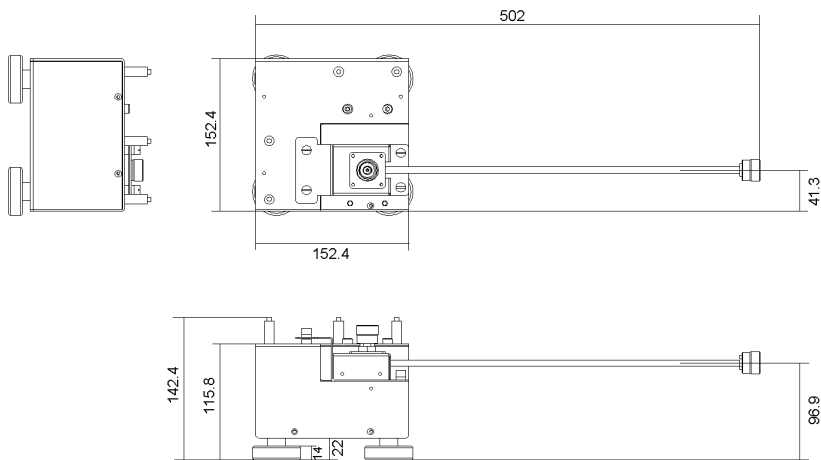

Figure 11. Option E4991A-007 test head dimensions (in millimeters, nominal)

General Characteristics *(continued)*

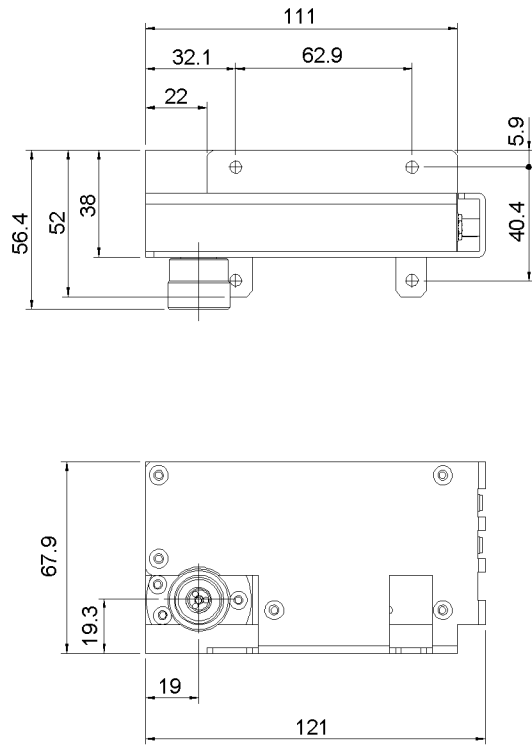

Figure 12. Option E4991A-010 test head dimensions (in millimeters,nominal)

Furnished accessories

| Model/option number | Agilent part number | Description | Qty |
|---------------------|---------------------|--|-------------------------------|
| Agilent E4991A | - | Agilent E4991A impedance/material analyzer (main unit) | 1 |
| | - | Test head | 1 |
| | - | Agilent 16195B 7-mm calibration kit | 1 |
| | 8710-1766 | Torque wrench | 1 |
| | - | Mouse ⁴ | 1 |
| | - | Keyboard ⁵ | 1 |
| | - | Power cable | 1 |
| | E4991-1610x | CD-ROM (firmware and VBA software) ⁶ | 1 |
| | E4991-905xx | CD-ROM (for manual) ⁶ | 1 |
| | Option 007 | E4991-60005 | Fixture station |
| E4991-60006 | | Test head stand | 1 |
| E4991-60032 | | 7-mm OPEN standard | 1 |
| E4991-60031 | | 7-mm SHORT standard | 1 |
| 04287-61651 | | RF extension cable assembly | 1 |
| 1250-2879 | | N (m) to SMA (f) adapter | 3 |
| 1250-3157 | | N (f) to SMA (f) adapter | 3 |
| E4991-18001 | | Floppy disk (Contains temperature characterisitc measurement software) | 1 |
| 04291-09001 | | Pad | 1 |
| 1400-0584 | | Mount cable tie | 1 |
| Option 010 | - | Test head (Including 1 m extension cable) | 1 |
| | 1250-2879 | N (m) to SMA (f) adapter | 3 |
| | 1250-1747 | 3.5-mm to 7-mm adapter | 1 |
| | 0515-1551 | Screw | 4 |
| | 3050-0891 | Washer | 4 |
| | Option ABA | E4991-900x0 | Operation manual ⁶ |
| E4991-900x1 | | Installation and quick start guide ⁶ | 1 |
| E4991-900x2 | | Programming manual ⁶ | 1 |
| E4991-180x0 | | Sample program disk (3.5 inch floppy disk) ⁶ | 1 |
| Option 1D5 | 8120-1838 | BNC(m)-BNC(m) cable ⁷ | 1 |
| Option 1CM | 5063-9216 | Rackmount kit | 1 |
| Option 1CN | 5063-9229 | Handle kit | 1 |
| Option 1CP | 5063-9223 | Rackmount & handle kit | 1 |

4. Not furnished if Option 1CS (without mouse) is designated.

5. Not furnished if Option 1A2 (without keyboard) is designated.

6. The number indicated by "x" in the part number of each manual, sample program disk, or CD-ROM, is incremented by 1 each time a revision is made. The latest edition comes with the product (0 for the first edition).

7. This cable is furnished if Option 1D5 high stability frequency reference is designated.

Option E4491A-002 Material Measurement (Typical)

Measurement parameter

Permittivity parameters:

$|\epsilon_r|, \epsilon_r', \epsilon_r'', \tan\delta$

Permeability parameters:

$|\mu_r|, \mu_r', \mu_r'', \tan\delta$

Frequency range

Using with Agilent 16453A:

1 MHz to 1 GHz (typical)

Using with Agilent 16454A:

1 MHz to 1 GHz (typical)

Measurement accuracy

Conditions for defining accuracy:

Calibration:

Open, short, and load calibration at the test port (7-mm connector)

Calibration temperature:

Calibration is performed at an environmental temperature within the range of $23\text{ }^\circ\text{C} \pm 5\text{ }^\circ\text{C}$. Measurement error doubles when calibration temperature is below $18\text{ }^\circ\text{C}$ or above $28\text{ }^\circ\text{C}$.

Temperature:

Temperature deviation: within $\pm 5\text{ }^\circ\text{C}$ from the calibration temperature

Environment temperature: Measurement accuracy applies when the calibration is performed at $23\text{ }^\circ\text{C} \pm 5\text{ }^\circ\text{C}$. When the calibration is below

$18\text{ }^\circ\text{C}$ or above $23\text{ }^\circ\text{C}$, measurement error doubles.

Measurement frequency points:

Same as calibration points

Oscillator level:

Same as the level set at calibration

Point averaging factor: ≥ 8

Electrode pressure setting of 16453A: maximum

Typical accuracy of permittivity parameters:

$$\epsilon_r' \text{ accuracy } \left[= \frac{\Delta\epsilon'_{rm}}{\epsilon'_{rm}} \right]:$$

$$\pm \left[5 + \left(10 + \frac{0.1}{f} \right) \frac{t}{\epsilon'_{rm}} + 0.25 \frac{\epsilon'_{rm}}{t} + \frac{100}{\left| 1 - \left(\frac{13}{f \sqrt{\epsilon'_{rm}}} \right)^2 \right|} \right] [\%]$$

(at $\tan\delta < 0.1$)

Loss tangent accuracy of ϵ_r ($= \Delta \tan\delta$):

$$\pm(E_a + E_b) \text{ (at } \tan\delta < 0.1)$$

where,

$$E_a =$$

at Frequency ≤ 1 GHz:

$$0.002 + \frac{0.001}{f} \cdot \frac{t}{\epsilon'_{rm}} + 0.004f + \frac{0.1}{\left| 1 - \left(\frac{13}{f \sqrt{\epsilon'_{rm}}} \right)^2 \right|}$$

$$E_b = \left[\frac{\Delta\epsilon'_{rm}}{\epsilon'_{rm}} \cdot \frac{1}{100} + \epsilon'_{rm} \frac{0.002}{t} \right] \tan\delta$$

f = Measurement frequency [GHz]

t = Thickness of MUT (material under test) [mm]

ϵ'_{rm} = Measured value of ϵ'_r

$\tan\delta$ = Measured value of dielectric loss tangent

Typical accuracy of permeability parameters:

μ'_{rm} accuracy

$$\left(= \frac{\Delta\mu'_{rm}}{\mu'_{rm}} \right):$$

$$4 + \frac{0.02}{f} \times \frac{25}{F\mu'_{rm}} + F\mu'_{rm} \left[1 + \frac{15}{F\mu'_{rm}} \right]^2 f^2 [\%]$$

(at $\tan\delta < 0.1$)

Loss tangent accuracy of $\dot{\mu}_r$ ($= \Delta\tan\delta$):

$$\pm(E_a + E_b) \text{ (at } \tan\delta < 0.1)$$

where,

$$E_a = 0.002 + \frac{0.001}{F\mu'_{rm}f} + 0.004f$$

$$E_b = \frac{\Delta\mu'_{rm}}{\mu'_{rm}} \cdot \frac{\tan\delta}{100}$$

f = Measurement frequency [GHz]

F = $h \ln \frac{c}{b}$ [mm]

h = Height of MUT (material under test) [mm]

b = Inner diameter of MUT (material under test) [mm]

c = Outer diameter of MUT (material under test) [mm]

μ'_{rm} = Measured value of μ'_r

$\tan\delta$ = Measured value of loss tangent

Option E4491A-002 Material Measurement (typical)

(continued)

Examples of calculated permittivity measurement accuracy

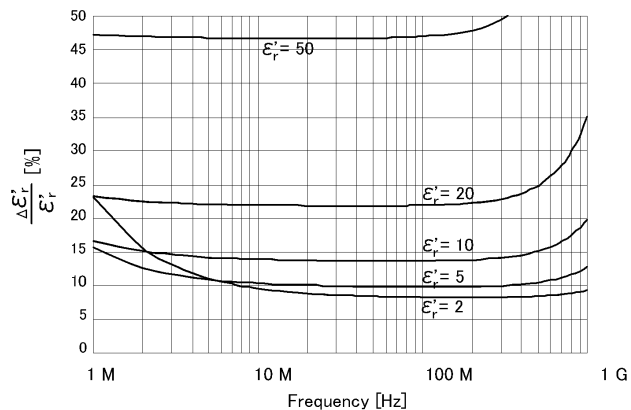

Figure 13. Permittivity accuracy $\frac{(\Delta\epsilon'_r)}{\epsilon'_r}$ vs. frequency (at $t = 0.3$ mm, typical)

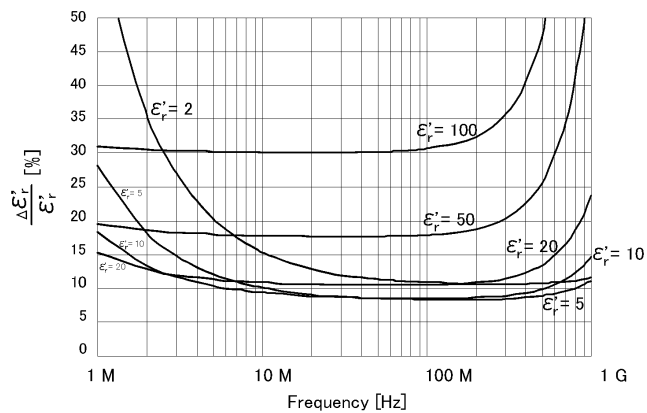

Figure 14. Permittivity accuracy $\frac{(\Delta\epsilon'_r)}{\epsilon'_r}$ vs. frequency (at $t = 1$ mm, typical)

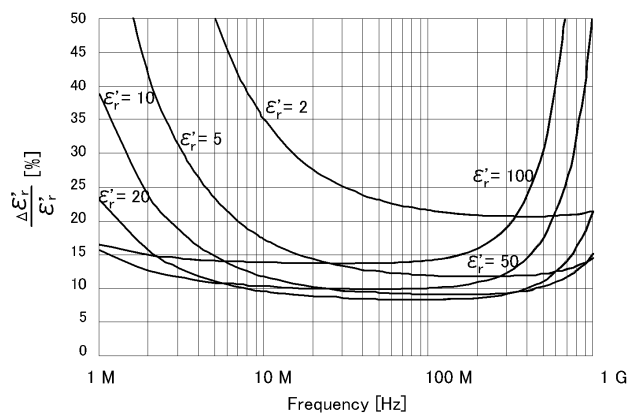

Figure 15. Permittivity accuracy $\frac{(\Delta\epsilon'_r)}{\epsilon'_r}$ vs. frequency (at $t = 3$ mm, typical)

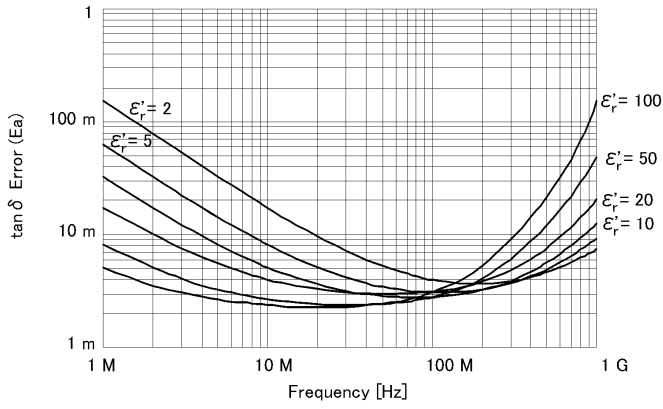

Figure 16. Dielectric loss tangent ($\tan\delta$) accuracy vs. frequency (at $t = 0.3$ mm, typical)⁸

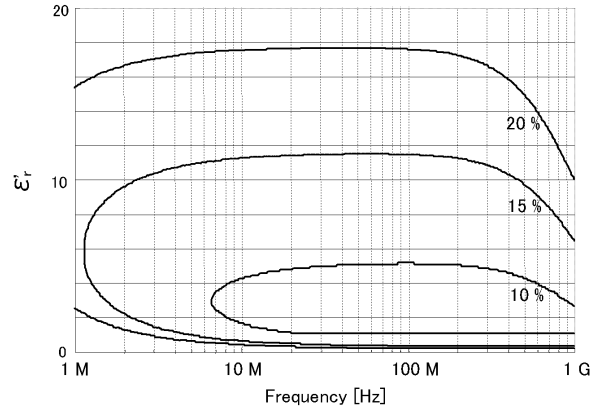

Figure 19. Permittivity (ϵ_r') vs. frequency (at $t = 0.3$ mm, typical)

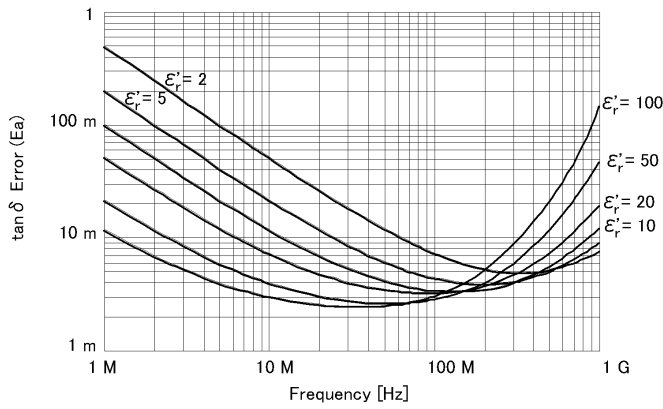

Figure 17. Dielectric loss tangent ($\tan\delta$) accuracy vs. frequency (at $t = 1$ mm, typical)⁸

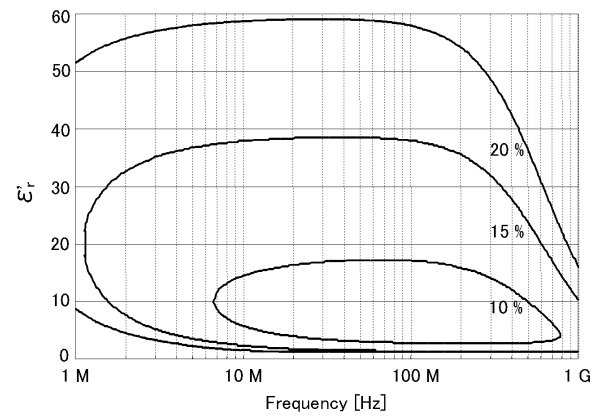

Figure 20. Permittivity (ϵ_r') vs. frequency (at $t = 1$ mm, typical)

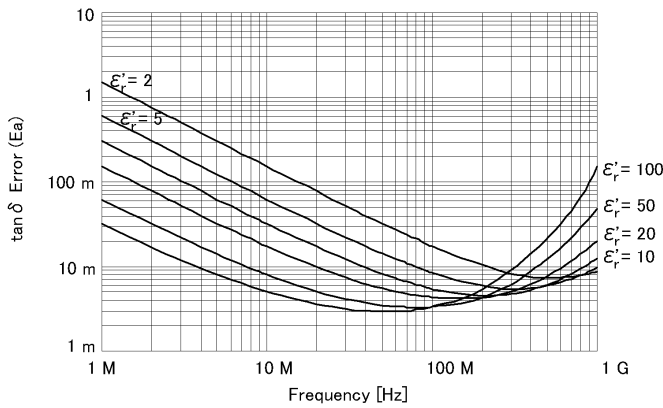

Figure 18. Dielectric loss tangent ($\tan\delta$) accuracy vs. frequency (at $t = 3$ mm, typical)⁸

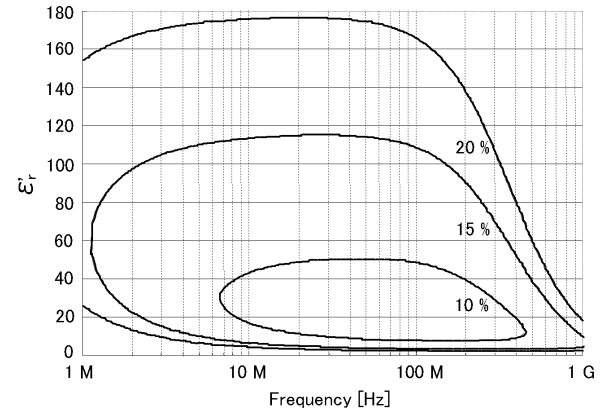

Figure 21. Permittivity (ϵ_r') vs. frequency (at $t = 3$ mm, typical)

⁸ This graph shows only frequency dependence of E_a to simplify it. The typical accuracy of $\tan\delta$ is defined as $E_a + E_b$, refer to "Typical accuracy of permittivity parameters" on page 17.

Option E4991A-002 Material Measurement (typical)

(continued)

Examples of calculated permeability measurement accuracy

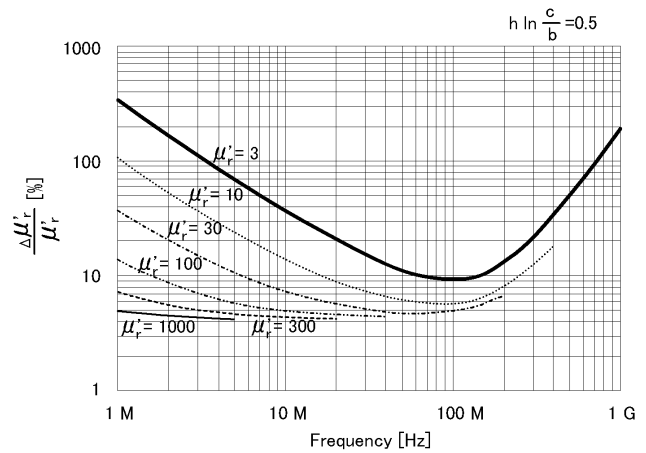

Figure 22. Permeability accuracy $\frac{(\Delta\mu'_r)}{\mu'_r}$ vs. frequency (at $F = 0.5$, typical)

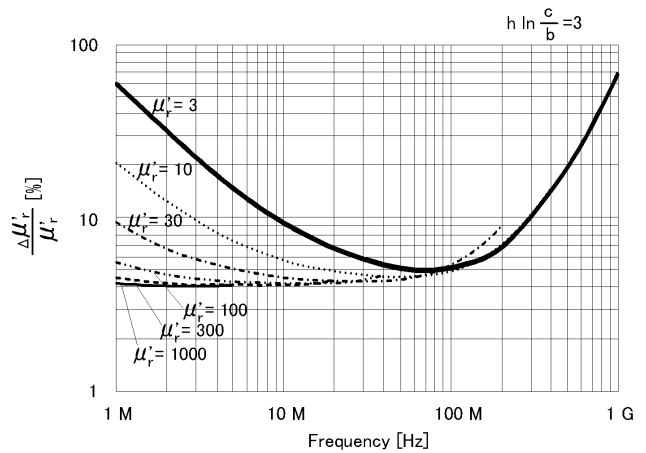

Figure 23. Permeability accuracy $\frac{(\Delta\mu'_r)}{\mu'_r}$ vs. frequency (at $F = 3$, typical)

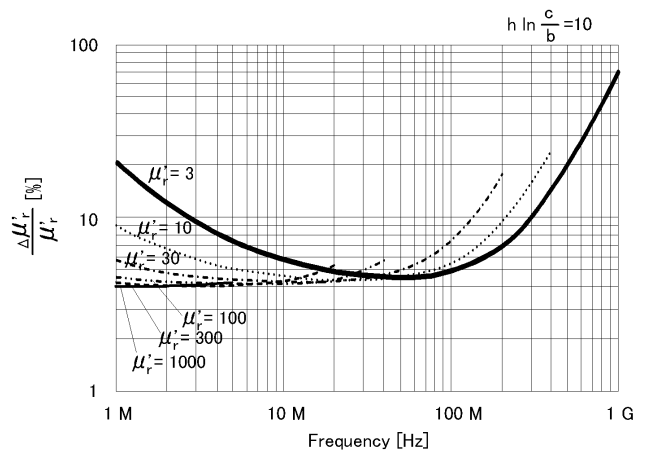

Figure 24. Permeability accuracy $\frac{(\Delta\mu'_r)}{\mu'_r}$ vs. frequency (at $F = 10$, typical)

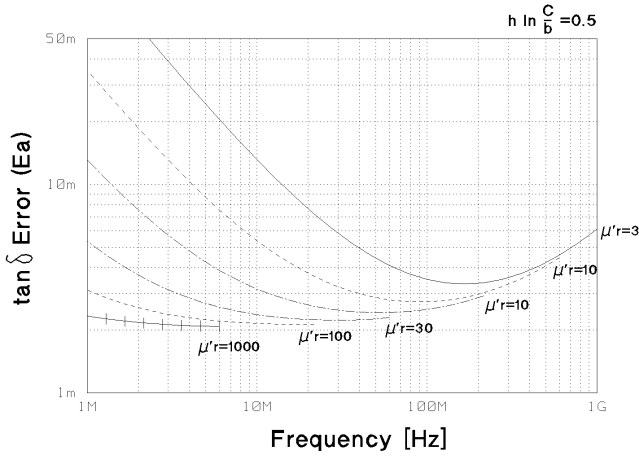

Figure 25. Permeability loss tangent ($\tan\delta$) accuracy vs. Frequency (at $F = 0.5$, typical)⁹

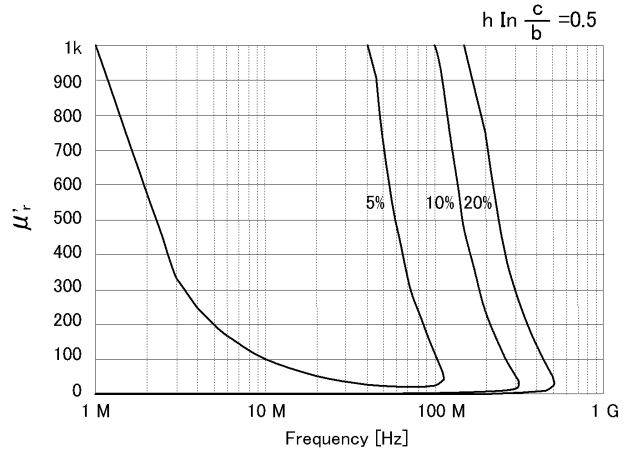

Figure 28. Permeability (μ'_r) vs. frequency (at $F = 0.5$, typical)

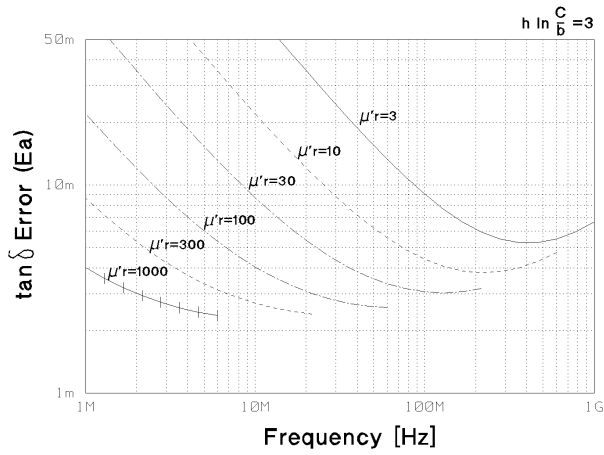

Figure 26. Permeability loss tangent ($\tan\delta$) accuracy vs. frequency (at $F = 3$, typical)⁹

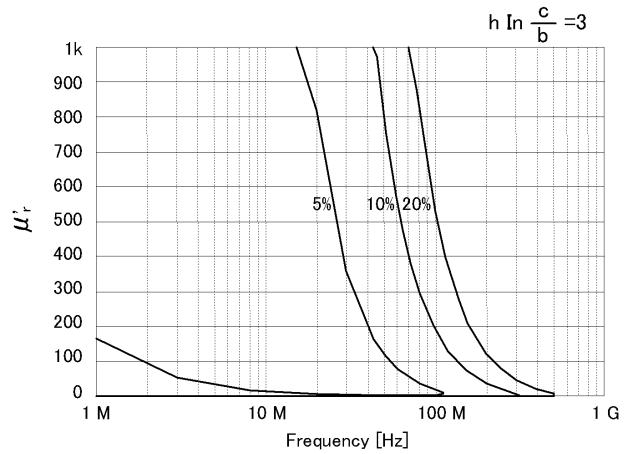

Figure 29. Permeability (μ'_r) vs. frequency (at $F = 3$, typical)

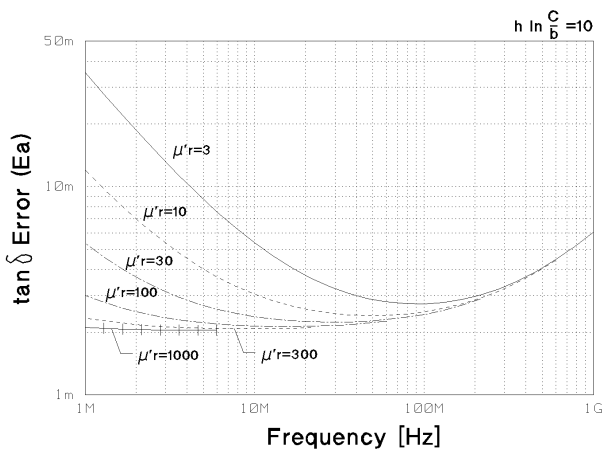

Figure 27. Permeability loss tangent ($\tan\delta$) accuracy vs. frequency (at $F = 10$, typical)⁹

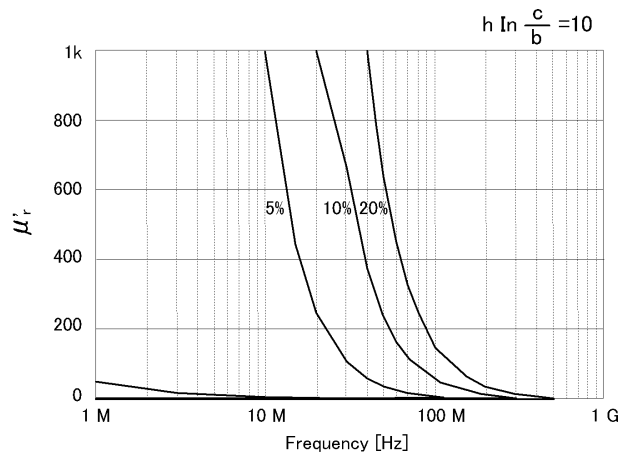

Figure 30. Permeability (μ'_r) vs. frequency (at $F = 10$, typical)

9. This graph shows only frequency dependence of E_a to simplify it. The typical accuracy of $\tan\delta$ is defined as $E_a + E_{\mu'_r}$; refer to "Typical accuracy of permeability parameters" on page 18.

Option E4991A-007 Temperature Characteristic Test Kit

This section contains specifications and supplemental information for the E4991A Option E4991A-007. Except for the contents in this section, the E4991A standard specifications and supplemental information are applied.

Operation temperature

Range:

-55 °C to +150 °C (at the test port of the high temperature cable)

Source characteristics

Frequency

Range:

1 MHz to 3 GHz

Oscillator level

Source power accuracy at the test port of the high temperature cable:

Frequency ≤ 1 GHz:

+2 dB/-4 dB (23 °C ±5 °C)

+4 dB/-6 dB (5 °C to 40 °C)

Frequency > 1 GHz:

+3 dB/-6 dB (23 °C ±5 °C)

+5 dB/-8 dB (5 °C to 40 °C)

Measurement accuracy (at 23 °C ±5 °C)

Conditions¹⁰

The measurement accuracy is specified when the following conditions are met:

Calibration: open, short and load calibration is completed at the test port (7-mm connector) of the high temperature cable

Calibration temperature: calibration is performed at an environmental temperature within the range of 23 °C ±5 °C. Measurement error doubles when calibration temperature is below 18 °C or above 28 °C.

Measurement temperature range: within ±5 °C of calibration temperature

Measurement plane: same as calibration plane

Oscillator level: same as the level set at calibration

Impedance, admittance and phase angle accuracy:

$$|Z|, |Y| \quad \pm (E_a + E_b) [\%]$$

(see Figure 31 through Figure 34 for calculated accuracy)

$$\theta \quad \pm \frac{(E_a + E_b)}{100} [\text{rad}]$$

where,

E_a = at oscillator level ≥ -33 dBm:

±0.8 [%] (1 MHz ≤ f ≤ 100 MHz)

±1 [%] (100 MHz < f ≤ 500 MHz)

±1.2 [%] (500 MHz < f ≤ 1 GHz)

±2.5 [%] (1 GHz < f ≤ 1.8 GHz)

±5 [%] (1.8 GHz < f ≤ 3 GHz)

at oscillator level ≥ -33 dBm:

±1.2 [%] (1 MHz ≤ f ≤ 100 MHz)

±1.5 [%] (100 MHz < f ≤ 500 MHz)

±1.5 [%] (500 MHz < f ≤ 1 GHz)

±2.5 [%] (1 GHz < f ≤ 1.8 GHz)

±5 [%] (1.8 GHz < f ≤ 3 GHz)

(Where, f is frequency)

$$E_b = \quad \pm \left[\frac{Z_s}{|Z_x|} + Y_o \times |Z_x| \right] \times 100 [\%]$$

Where,

$|Z_x|$ = Absolute value of impedance

Z_s = At oscillator level = -3 dBm, -13 dBm, or -23 dBm:

± (30 + 0.5 × F) [mΩ] (point averaging factor ≥ 8)

± (40 + 0.5 × F) [mΩ] (point averaging factor ≤ 7)

At oscillator level ≥ -33 dBm:

± (35 + 0.5 × F) [mΩ] (point averaging factor ≥ 8)

± (70 + 0.5 × F) [mΩ] (point averaging factor ≤ 7)

At oscillator level < -33 dBm:

± (50 + 0.5 × F) [mΩ] (point averaging factor ≥ 8)

± (150 + 0.5 × F) [mΩ] (point averaging factor ≤ 7)

(Where, F is frequency in MHz)

Y_o = At oscillator level = -3 dBm, -13 dBm, -23 dBm:

± (12 + 0.1 × F) [μS] (point averaging factor ≥ 8)

± (20 + 0.1 × F) [μS] (point averaging factor ≤ 7)

At oscillator level ≥ -33 dBm:

± (15 + 0.1 × F) [μS] (point averaging factor ≥ 8)

± (40 + 0.1 × F) [μS] (point averaging factor ≤ 7)

At oscillator level < -33 dBm:

± (35 + 0.1 × F) [μS] (point averaging factor ≥ 8)

± (80 + 0.1 × F) [μS] (point averaging factor ≤ 7)

(Where, F is frequency in MHz)

10. The high temperature cable must be kept at the same position throughout calibration and measurement.

Calculated Impedance/ Admittance Measurement Accuracy

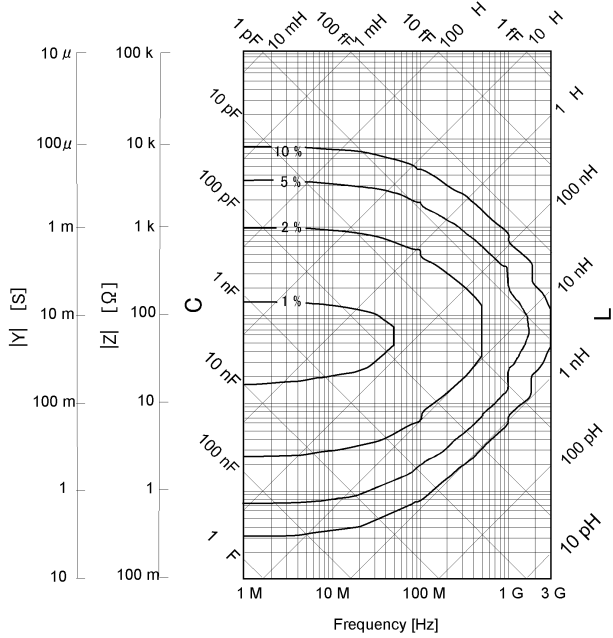

Figure 31. $|Z|$, $|Y|$ measurement accuracy when open/short/load calibration is performed. Oscillator level = -23 dBm, -13 dBm, -3 dBm. Point averaging factor ≥ 8 within ± 5 °C of calibration temperature.

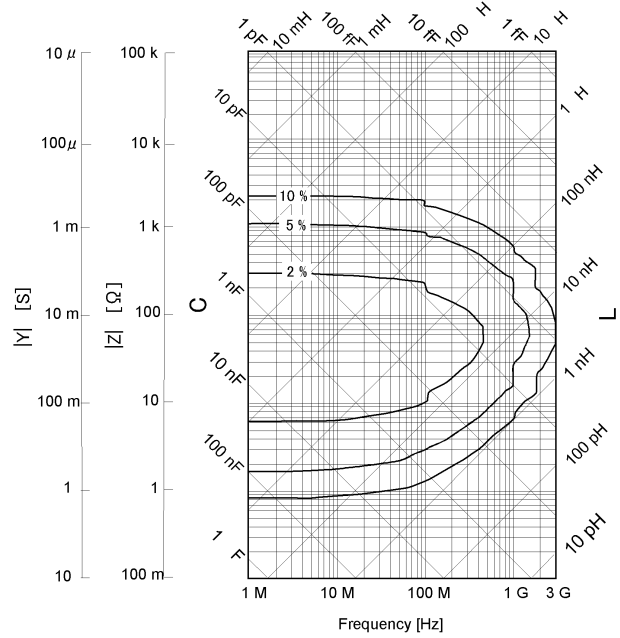

Figure 33. $|Z|$, $|Y|$ measurement accuracy when open/short/load calibration is performed. Oscillator level ≥ -33 dBm. Point averaging factor ≤ 7 within ± 5 °C of calibration temperature.

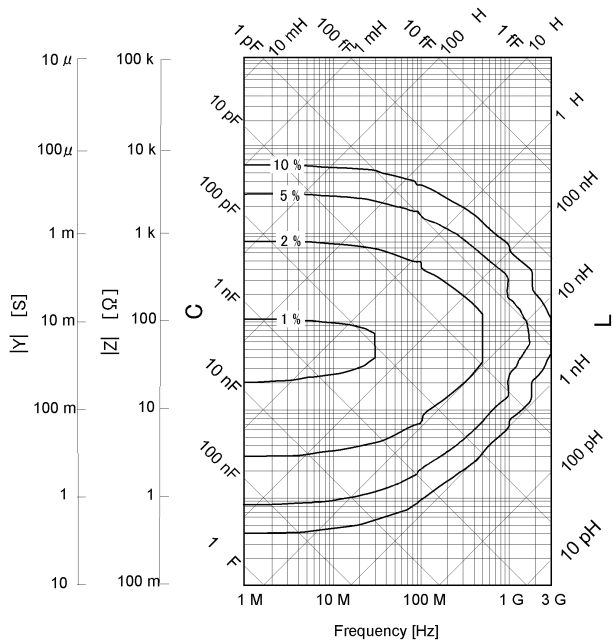

Figure 32. $|Z|$, $|Y|$ measurement accuracy when open/short/load calibration is performed. Oscillator level ≥ -33 dBm. Point averaging factor ≥ 8 within ± 5 °C of calibration temperature.

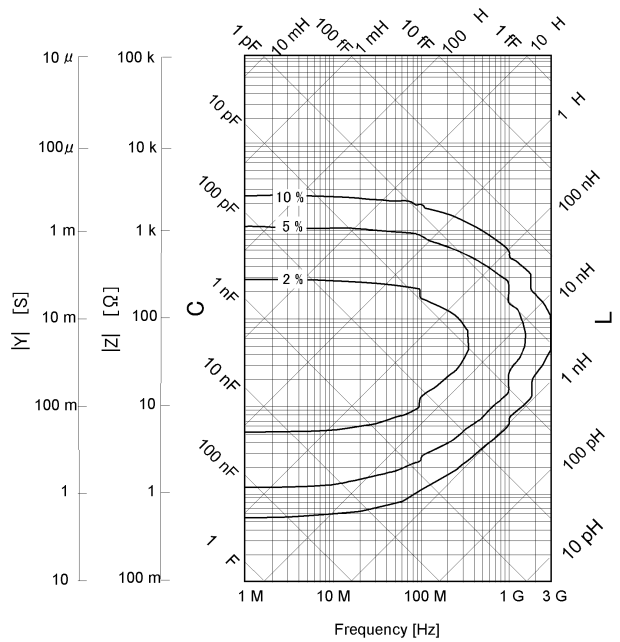

Figure 34. $|Z|$, $|Y|$ measurement accuracy when open/short/load calibration is performed. Oscillator level < -33 dBm. Point averaging factor ≥ 8 within ± 5 °C of calibration temperature.

Typical Effects of Temperature Change on Measurement Accuracy

When the temperature at the test port (7-mm connector) of the high temperature cable changes from the calibration temperature, typical measurement accuracy involving temperature dependence effects (errors) is applied. The typical measurement accuracy is represented by the sum of error due to temperature coefficients (E_a' , Y_o' and Z_s'), hysteresis error (E_{ah} , Y_{oh} and Z_{sh}) and the specified accuracy.

Conditions

The typical measurement accuracy is applied when the following conditions are met:

Conditions of E_a' , Z_s' and Y_o' :

Measurement temperature: $-55\text{ }^{\circ}\text{C}$ to $5\text{ }^{\circ}\text{C}$ or $40\text{ }^{\circ}\text{C}$ to $150\text{ }^{\circ}\text{C}$ at test port. For $5\text{ }^{\circ}\text{C}$ to $40\text{ }^{\circ}\text{C}$, E_a' , Y_o' and Z_s' are 0 (neglected).

Temperature change: $\geq 5\text{ }^{\circ}\text{C}$ from calibration temperature when the temperature compensation is off.

$\geq 20\text{ }^{\circ}\text{C}$ from calibration temperature when the temperature compensation is set to on.

Calibration temperature: $23\text{ }^{\circ}\text{C} \pm 5\text{ }^{\circ}\text{C}$

Calibration mode: user calibration

Temperature compensation: temperature compensation data is acquired at the same temperature points as measurement temperatures.

Conditions of E_{ah} , Z_{sh} and Y_{oh} :

Measurement temperature: $-55\text{ }^{\circ}\text{C}$ to $150\text{ }^{\circ}\text{C}$ at the test port

Calibration temperature: $23\text{ }^{\circ}\text{C} \pm 5\text{ }^{\circ}\text{C}$

Calibration mode: user calibration

Typical measurement accuracy (involving temperature dependence effects)¹¹:

$$|Z|, |Y|: \pm (E_a + E_b + E_c + E_d) [\%]$$

$$\theta : \pm \frac{(E_a + E_b + E_c + E_d)}{100} [\text{rad}]$$

Where,

$$E_c = E_a' \times \Delta T + E_{ah}$$

$$E_d = \pm \left[\frac{Z_s' \times \Delta T + Z_{sh}}{|Z_x|} + (Y_o' \times \Delta T + Y_{oh}) \times |Z_x| \right] \times 100 [\%]$$

Where,

$$|Z_x| = \text{Absolute value of measured impedance}$$

Here, E_a' , Z_s' and Y_o' are given by the following equations:

| | Without temperature compensation | With temperature compensation | |
|--------|----------------------------------|-------------------------------|--------------------------|
| | | 1 MHz ≤ f < 500 MHz | 500 MHz ≤ f ≤ 3 GHz |
| E_a' | 0.006 + 0.015 × f [%/°C] | 0.006 + 0.015 × f [%/°C] | 0.006 + 0.015 × f [%/°C] |
| Z_s' | 1 + 10 × f [mΩ/°C] | 1 + 10 × f [mΩ/°C] | 5 + 2 × f [mΩ/°C] |
| Y_o' | 0.3 + 3 × f [μS/°C] | 0.3 + 3 × f [μS/°C] | 1.5 + 0.6 × f [μS/°C] |

f = Measurement frequency in GHz

E_{ah} , Z_{sh} and Y_{oh} are given by following equations:

$$E_{ah} = E_a' \times \Delta T_{max} \times 0.3 [\%]$$

$$Z_{sh} = Z_s' \times \Delta T_{max} \times 0.3 [\text{m}\Omega]$$

$$Y_{oh} = Y_o' \times \Delta T_{max} \times 0.3 [\mu\text{S}]$$

ΔT = Difference of measurement temperature from calibration temperature

ΔT_{max} = Maximum temperature change (°C) at the test port from calibration temperature after the calibration is performed.

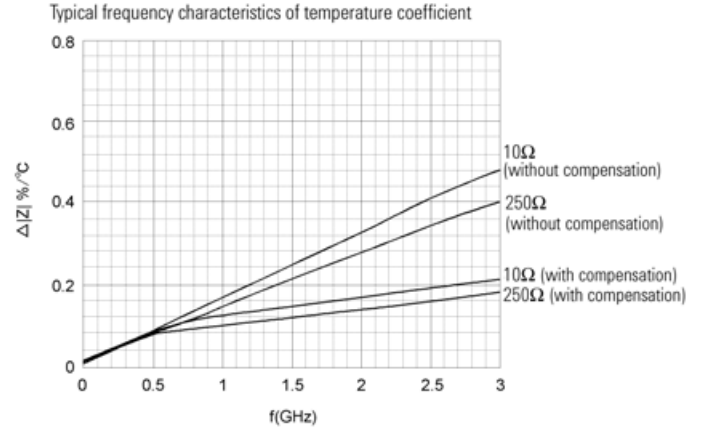

Figure 35. Typical frequency characteristics of temperature coefficient, $(E_c+E_d)/\Delta T$, when $|Z_x| = 10 \Omega$ and 250Ω , $E_{ah} = Z_{sh} = Y_{oh} = 0$ are assumed¹².

11. See graphs in Figure 35 for the calculated values of (E_c+E_d) exclusive of the hysteresis errors E_{ah} , Z_{sh} and Y_{oh} , when measured impedance is 10Ω and 250Ω .

12. Read the value of $\Delta|Z| \text{ %/}^\circ\text{C}$ at the material measurement frequency and multiply it by ΔT to derive the value of (E_c+E_d) when $E_{ah} = Y_{oh} = Z_{sh} = 0$.

Typical Material Measurement Accuracy When Using Options E4991A-002 and E4991A-007

Material measurement accuracy contains the permittivity and permeability measurement accuracy when the E4991A with Option E4991A-002 and E4991A-007 is used with the 16453A or 16454A test fixture.

Measurement parameter

Permittivity parameters:

$|\epsilon_r|, \epsilon'_r, \epsilon'', \tan\delta$

Permeability parameters:

$|\mu_r|, \mu'_r, \mu'', \tan\delta$

Frequency

Use with Agilent 16453A:

1 MHz to 1 GHz (typical)

Use with Agilent 16454A:

1 MHz to 1 GHz (typical)

Operation temperature

Range:

-55 °C to +150 °C (at the test port of the high temperature cable)

Typical material measurement accuracy (at 23 °C ±150 °C)

Conditions

The measurement accuracy is specified when the following conditions are met:

Calibration: Open, short and load calibration is completed at the test port (7-mm connector) of the high temperature cable

Calibration temperature: Calibration is performed at an environmental temperature within the range of 23 °C ±5 °C. Measurement error doubles when calibration temperature is below 18 °C or above 28 °C.

Measurement temperature range: Within ±5 °C of calibration temperature

Measurement frequency points: Same as calibration points (User Cal)

Oscillator level: Same as the level set at calibration

Point averaging factor: ≥ 8

Typical permittivity measurement accuracy¹³:

$$\epsilon'_r \text{ accuracy} \left(E_\epsilon = \frac{\Delta\epsilon'_r}{\epsilon'_r} \right):$$

$$\pm \left[5 + \left(10 + \frac{0.5}{f} \right) \times \frac{t}{\epsilon'_r} + 0.25 \times \frac{\epsilon'_r}{t} + \frac{100}{\left| 1 - \left(\frac{13}{f\sqrt{\epsilon'_r}} \right)^2 \right|} \right]$$

[%] (at $\tan\delta < 0.1$)

Loss tangent accuracy of ϵ_r (= $\Delta\tan\delta$):

$$\pm (E_a + E_b) \text{ (at } \tan\delta < 0.1)$$

where,

$$E_a =$$

at Frequency ≤ 1 GHz

$$0.002 + \frac{0.0025}{f} \times \frac{t}{\epsilon'_r} + (0.008 \times f) + \frac{0.1}{\left| 1 - \left(\frac{13}{f\sqrt{\epsilon'_r}} \right)^2 \right|}$$

$$E_b = \left[\frac{\Delta\epsilon'_r}{\epsilon'_r} \times \frac{1}{100} + \epsilon'_r \frac{0.002}{t} \right] \times \tan\delta$$

f = Measurement frequency [GHz]

t = Thickness of MUT (material under test) [mm]

ϵ'_r = Measured value of ϵ'_r

$\tan\delta$ = Measured value of dielectric loss tangent

13. The accuracy applies when the electrode pressure of the 16453A is set to maximum.

Typical permeability measurement accuracy :

$$\mu_r' \text{ accuracy} \quad E_{\mu} = \left(\frac{\Delta\mu'_{rm}}{\mu'_{rm}} \right) :$$
$$4 + \frac{0.02}{f} \times \frac{25}{F \times \mu'_{rm}} + F \times \mu'_{rm} \times \left(1 + \frac{15}{F \times \mu'_{rm}} \right)^2 \times f^2$$

[%] (at $\tan\delta < 0.1$)

Loss tangent accuracy of μ_r (= $\Delta\tan\delta$) :

$$\pm (E_a + E_b) \text{ (at } \tan\delta < 0.1)$$

where,

$$E_a = 0.002 + \frac{0.005}{F \times \mu'_{rm} \times f} + 0.004 \times f$$

$$E_b = \frac{\Delta\mu'_{rm}}{\mu'_{rm}} \times \frac{\tan\delta}{100}$$

f = Measurement frequency [GHz]

$$F = h \ln \frac{c}{b} \text{ [mm]}$$

h = Height of MUT (material under test) [mm]

b = Inner diameter of MUT [mm]

c = Outer diameter of MUT [mm]

μ'_{rm} = Measured value of μ_r'

$\tan\delta$ = Measured value of loss tangent

Examples of Calculated Permittivity Measurement Accuracy

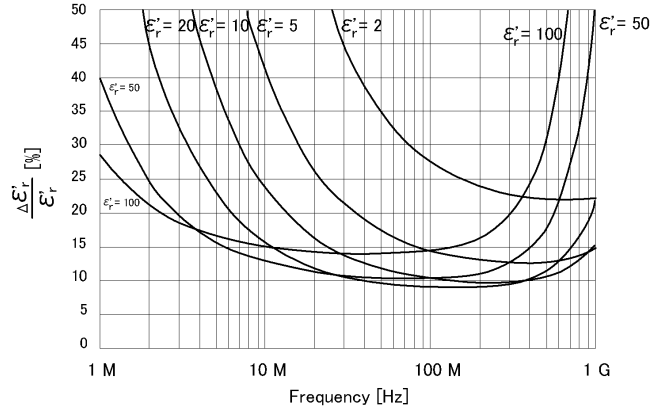

Figure 38. Permittivity accuracy $\frac{(\Delta\epsilon')}{\epsilon'}$ vs. frequency (at $t = 3$ mm, typical)

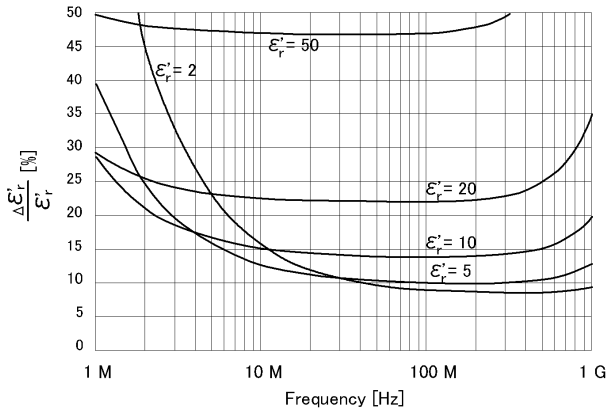

Figure 36. Permittivity accuracy $\frac{(\Delta\epsilon')}{\epsilon'}$ vs. frequency (at $t = 0.3$ mm, typical)

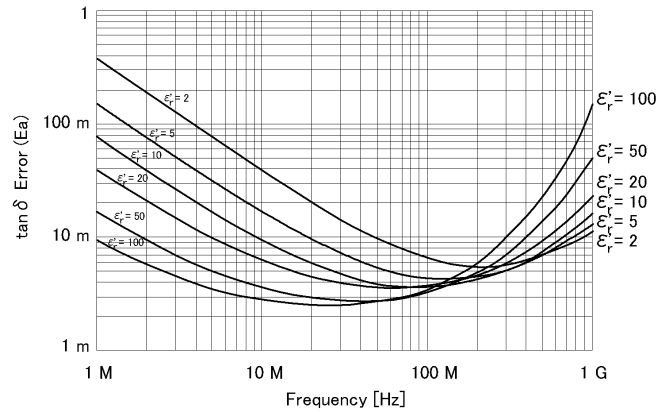

Figure 39. Dielectric loss tangent ($\tan\delta$) accuracy vs. frequency (at $t = 0.3$ mm, typical)¹⁴

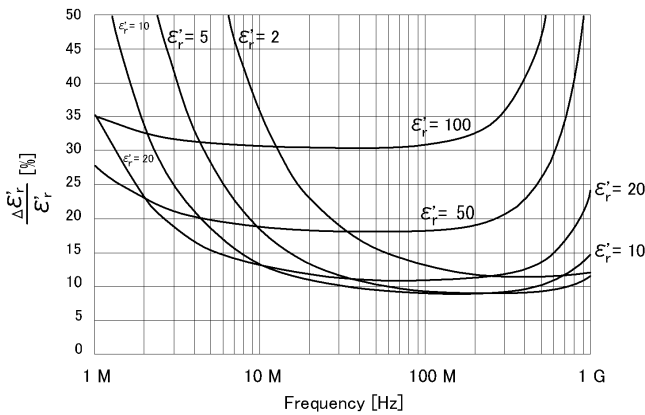

Figure 37. Permittivity accuracy $\frac{(\Delta\epsilon')}{\epsilon'}$ vs. frequency (at $t = 1$ mm, typical)

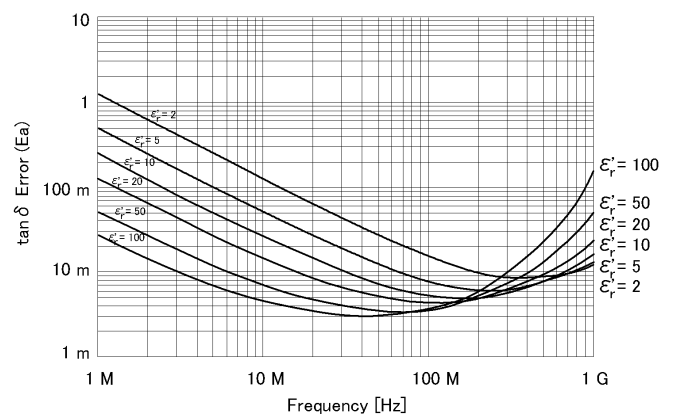

Figure 40. Dielectric loss tangent ($\tan\delta$) accuracy vs. frequency (at $t = 1$ mm, typical)¹⁴

14. This graph shows only frequency dependence of E_a for simplification. The typical accuracy of $\tan\delta$ is defined as $E_a + E_b$; refer to "Typical permittivity measurement accuracy" on page 27.

Examples of Calculated Permittivity Measurement Accuracy *(continued)*

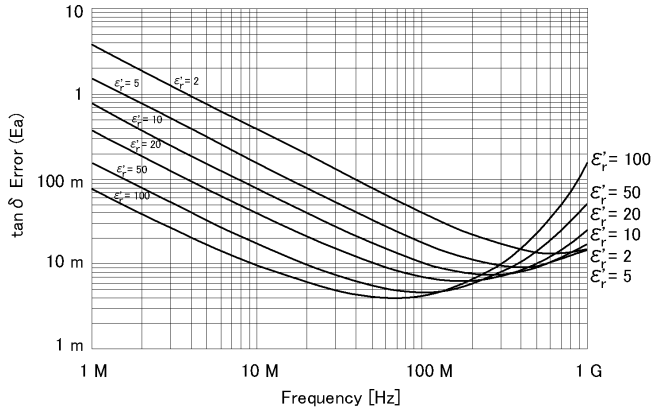

Figure 41. Dielectric loss tangent ($\tan\delta$) accuracy vs. frequency (at $t = 3$ mm, typical)¹⁴

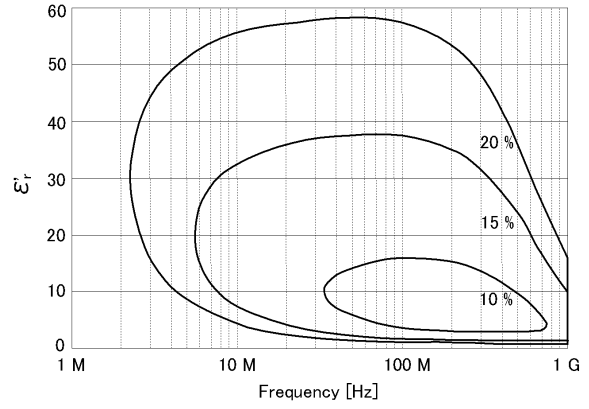

Figure 43. Permittivity (ϵ'_r) vs. frequency (at $t = 1$ mm, typical)

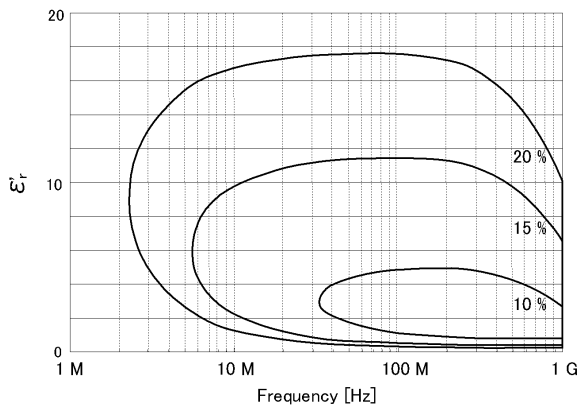

Figure 42. Permittivity (ϵ'_r) vs. frequency (at $t = 0.3$ mm, typical)

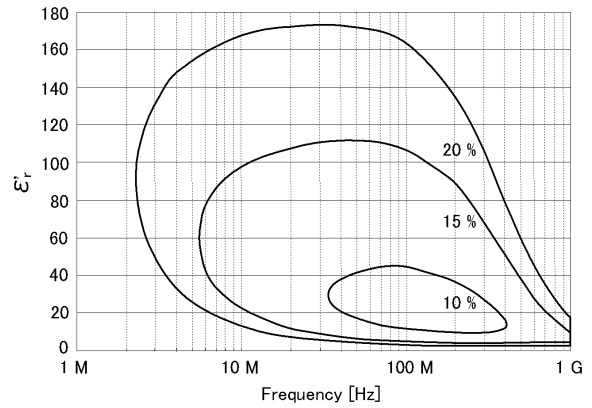

Figure 44. Permittivity (ϵ'_r) vs. frequency (at $t = 3$ mm, typical)

14. This graph shows only frequency dependence of E_a for simplification. The typical accuracy of $\tan\delta$ is defined as $E_a + E_b$; refer to "Typical permittivity measurement accuracy" on page 27.

Examples of Calculated Permeability Measurement Accuracy

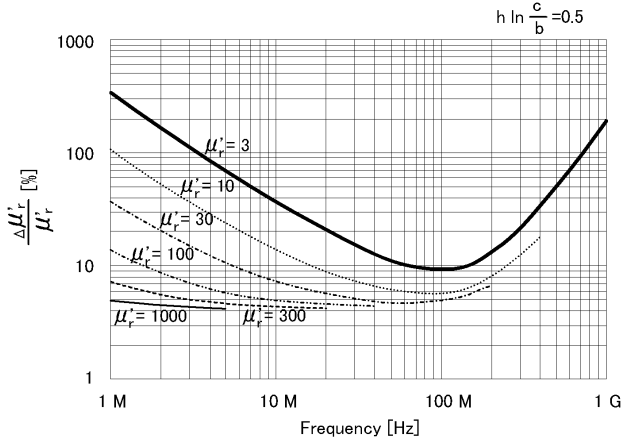

Figure 45. Permeability accuracy $\frac{\Delta\mu'}{\mu'}$ vs. frequency (at $F = 0.5$, typical)

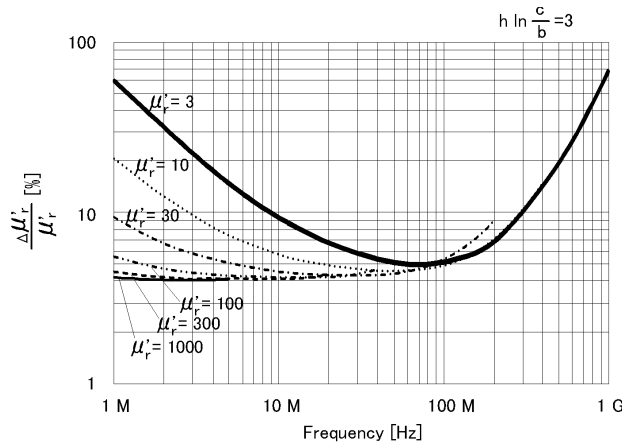

Figure 46. Permeability accuracy $\frac{\Delta\mu'}{\mu'}$ vs. frequency (at $F = 3$, typical)

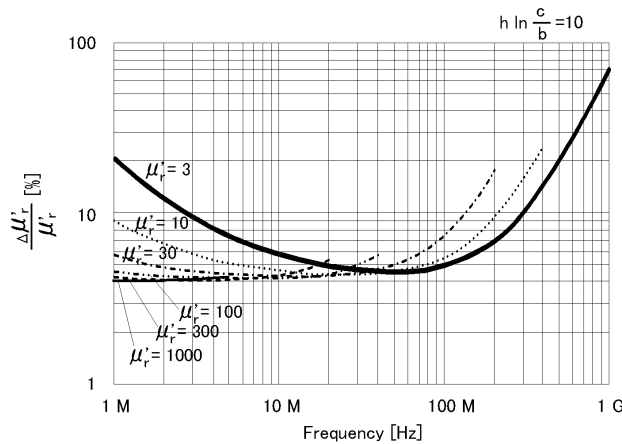

Figure 47. Permeability accuracy $\frac{\Delta\mu'}{\mu'}$ vs. frequency (at $F = 10$, typical)

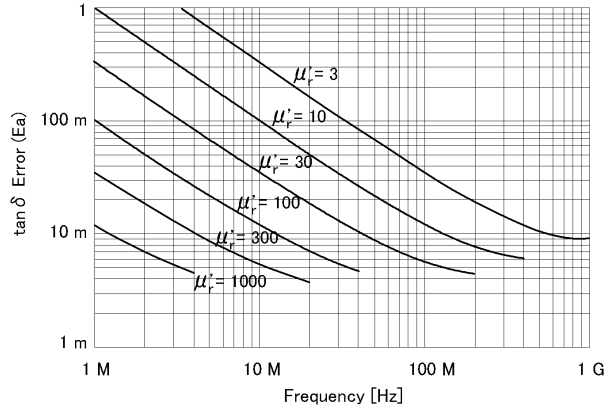

Figure 48. Permeability loss tangent ($\tan\delta$) accuracy vs. Frequency (at $F = 0.5$, typical)¹⁵

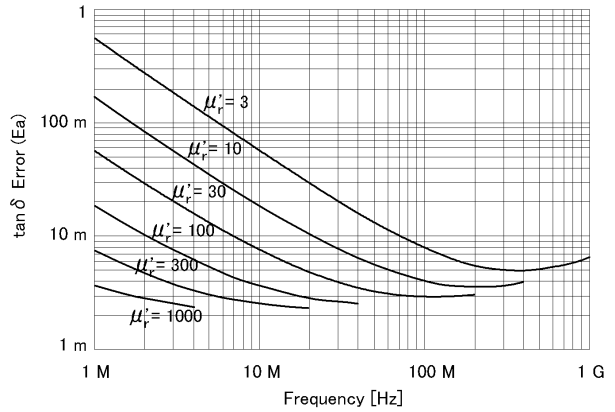

Figure 49. Permeability loss tangent ($\tan\delta$) accuracy vs. Frequency (at $F = 3$, typical)¹⁵

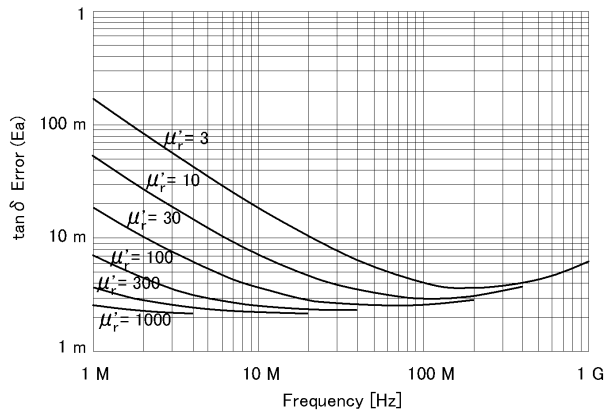

Figure 50. Permeability loss tangent ($\tan\delta$) accuracy vs. Frequency (at $F = 10$, typical)¹⁵

15. This graph shows only frequency dependence of E_a for simplification. The typical accuracy of $\tan\delta$ is defined as $E_a + E_b$; refer to "Typical permeability measurement accuracy" on page 28.

Examples of Calculated Permeability Measurement Accuracy (continued)

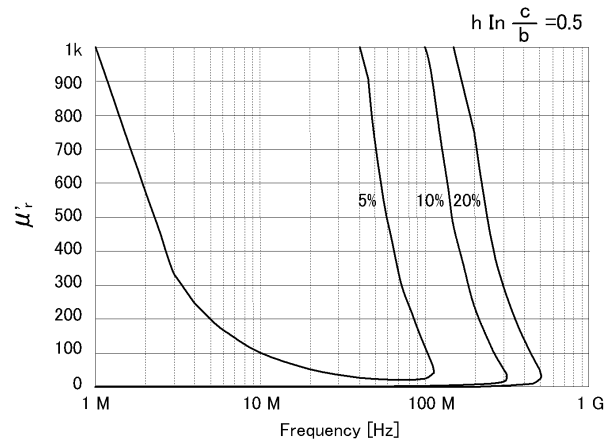

Figure 51. Permeability (μ_r) vs. frequency (at $F = 0.5$, typical)

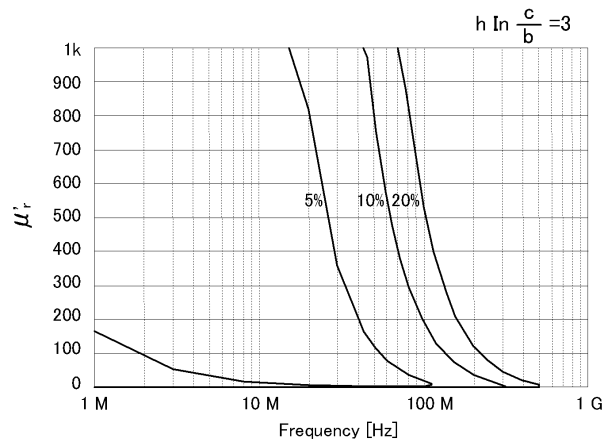

Figure 52. Permeability (μ_r) vs. frequency (at $F = 3$, typical)

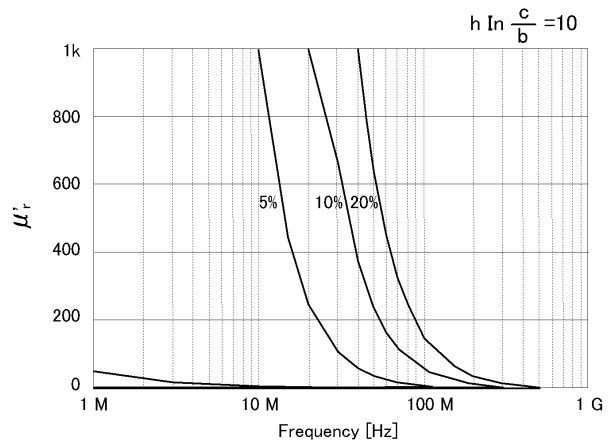

Figure 53. Permeability (μ_r) vs. frequency (at $F = 10$, typical)

Typical Effects of Temperature Change on Permittivity Measurement Accuracy

When the temperature at the test port (7-mm connector) of the high temperature cable changes more than 5 °C from the calibration temperature, the typical permittivity measurement accuracy involving temperature dependence effects (errors) is applied. The typical permittivity accuracy is represented by the sum of error due to temperature coefficient (T_c), hysteresis error ($T_c \times \Delta T_{max}$) and the accuracy at 23 °C \pm 5 °C.

Typical accuracy of permittivity parameters:

$$\epsilon_r' \text{ accuracy} = \left(\frac{\Delta \epsilon_{rm}'}{\epsilon_{rm}'} \right) : \\ \pm (E_\epsilon + E_f + E_g) [\%]$$

Loss tangent accuracy of $\dot{\epsilon}$ (= $\Delta \tan \delta$) :

$$\pm \frac{(E_\epsilon + E_f + E_g)}{100}$$

where,

$$E_\epsilon = \text{Permittivity measurement accuracy at } 23 \text{ }^\circ\text{C} \pm 5 \text{ }^\circ\text{C}$$

$$E_f = T_c \times \Delta T$$

$$E_g = T_c \times \Delta T_{max} \times 0.3$$

$$T_c = K_1 + K_2 + K_3$$

See Figure 54 through Figure 56 for the calculated value of T_c without temperature compensation

$$K_1 = 1 \times 10^{-6} \times (60 + 150 \times f)$$

$$K_2 =$$

$$3 \times 10^{-6} \times (1 + 10 \times f) \times \left(\frac{\epsilon_{rm}'}{t} \times \left| \frac{1}{1 - \left(\frac{f}{f_o} \right)^2} \right| + 10 \right) \times f$$

$$K_3 =$$

$$5 \times 10^{-3} \times (0.3 + 3 \times f) \times \left(\frac{1}{\left(\frac{\epsilon_{rm}'}{t} \times \left| \frac{1}{1 - \left(\frac{f}{f_o} \right)^2} \right| + 10 \right) \times f} \right)$$

Typical accuracy of permittivity parameters (continued):

with temperature compensation

$$K_1 = 1 \times 10^{-6} \times (60 + 150 \times f)$$

$$K_2 = 1 \text{ MHz} \leq f < 500 \text{ MHz}$$

$$3 \times 10^{-6} \times (1 + 10 \times f) \times \left(\frac{\epsilon'_{rm}}{t} \times \left| \frac{1}{1 - \left(\frac{f}{f_o}\right)^2} \right| + 10 \right) \times f$$

$$500 \text{ MHz} \leq f \leq 1 \text{ GHz}$$

$$3 \times 10^{-6} \times (5 + 2 \times f) \times \left(\frac{\epsilon'_{rm}}{t} \times \left| \frac{1}{1 - \left(\frac{f}{f_o}\right)^2} \right| + 10 \right) \times f$$

$$K_3 = 1 \text{ MHz} \leq f < 500 \text{ MHz}$$

$$\frac{1}{5 \times 10^{-3} \times (0.3 + 3 \times f) \times \left(\frac{\epsilon'_{rm}}{t} \times \left| \frac{1}{1 - \left(\frac{f}{f_o}\right)^2} \right| + 10 \right) \times f}$$

$$500 \text{ MHz} \leq f \leq 1 \text{ GHz}$$

$$\frac{1}{5 \times 10^{-3} \times (1.5 + 0.6 \times f) \times \left(\frac{\epsilon'_{rm}}{t} \times \left| \frac{1}{1 - \left(\frac{f}{f_o}\right)^2} \right| + 10 \right) \times f}$$

f = Measurement frequency [GHz]

$$f_o = \frac{13}{\sqrt{\epsilon'_r}} \text{ [GHz]}$$

t = Thickness of MUT (material under test) [mm]

ϵ'_{rm} = Measured value of ϵ'_r

ΔT = Difference of measurement temperature from calibration temperature

ΔT_{max} = Maximum temperature change ($^{\circ}\text{C}$) at test port from calibration temperature after the calibration is performed.

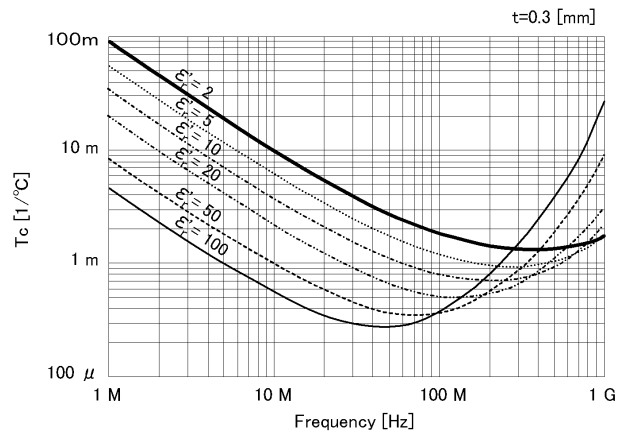

Figure 54. Typical frequency characteristics of temperature coefficient of ϵ'_r (Thickness = 0.3 mm)

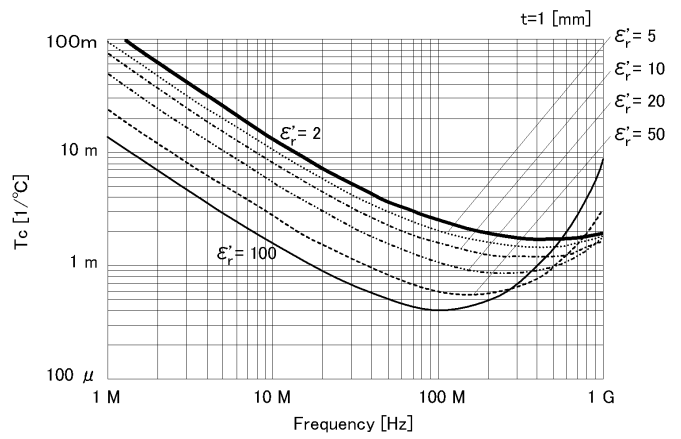

Figure 55. Typical frequency characteristics of temperature coefficient of ϵ'_r (Thickness = 1 mm)

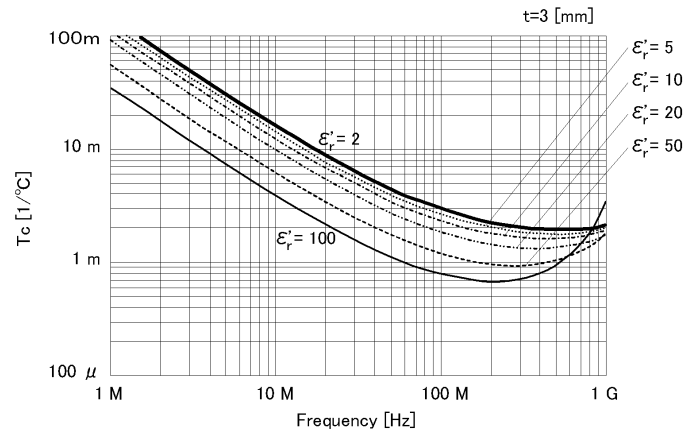

Figure 56. Typical frequency characteristics of temperature coefficient of ϵ'_r (Thickness = 3 mm)

Typical Effects of Temperature Change on Permeability Measurement Accuracy

When the temperature at the test port (7-mm connector) of the high temperature cable changes more than 5 °C from the calibration temperature, the typical permeability measurement accuracy involving temperature dependence effects (errors) is applied. The typical permeability accuracy is represented by the sum of error due to temperature coefficient (T_c), hysteresis error ($T_c \times \Delta T_{max}$) and the accuracy at 23 °C ± 5 °C.

Typical accuracy of permeability parameters:

$$\mu_r' \text{ accuracy} = \left(\frac{\Delta \mu_{rm}'}{\mu_{rm}'} \right) : \pm (E_\mu + E_h + E_i) [\%]$$

Loss tangent accuracy of μ_r (= $\Delta \tan \delta$) :

$$\pm \frac{(E_\mu + E_h + E_i)}{100}$$

where,

$$E_\mu = \text{Permeability measurement accuracy at } 23 \text{ }^\circ\text{C} \pm 5 \text{ }^\circ\text{C}$$

$$E_h = T_c \times \Delta T$$

$$E_i = T_c \times \Delta T_{max} \times 0.3$$

$$T_c = K_4 + K_5 + K_6$$

See Figure 57 through Figure 59 for the calculated value of T_c

without temperature compensation

$$K_4 = 1 \times 10^{-6} \times (60 + 150 \times f)$$

$$K_5 =$$

$$1 \times 10^{-2} \times (1 + 10 \times f) \times \frac{|1 - 0.01 \times \{F \times (\mu_{rm}' - 1) + 10\} \times f^2|}{\{F \times (\mu_{rm}' - 1) + 20\} \times f}$$

$$K_6 =$$

$$2 \times 10^{-6} \times (0.3 + 3 \times f) \times \frac{\{F \times (\mu_{rm}' - 1) + 20\} \times f}{|1 - 0.01 \times \{F \times (\mu_{rm}' - 1) + 10\} \times f^2|}$$

with temperature compensation

$$K_4 = 1 \times 10^{-6} \times (60 + 150 \times f)$$

$$K_5 =$$

$$1 \text{ MHz} \leq f < 500 \text{ MHz}$$

$$1 \times 10^{-2} \times (1 + 10 \times f) \times \frac{|1 - 0.01 \times \{F \times (\mu_{rm}' - 1) + 10\} \times f^2|}{\{F \times (\mu_{rm}' - 1) + 20\} \times f}$$

$$500 \text{ MHz} \leq f \leq 1 \text{ GHz}$$

$$1 \times 10^{-2} \times (5 + 2 \times f) \times \frac{|1 - 0.01 \times \{F \times (\mu_{rm}' - 1) + 10\} \times f^2|}{\{F \times (\mu_{rm}' - 1) + 20\} \times f}$$

Typical accuracy of permeability parameters (continued):

$$K_6 = 1 \text{ MHz} \leq f < 500 \text{ MHz}$$
$$2 \times 10^{-6} \times (0.3 + 3 \times f) \times \frac{\{F \times (\mu'_{rm} - 1) + 20\} \times f}{|1 - 0.01 \times \{F \times (\mu'_{rm} - 1) + 10\} \times f^2|}$$

$$500 \text{ MHz} \leq f \leq 1 \text{ GHz}$$
$$2 \times 10^{-6} \times (1.5 + 0.6 \times f) \times \frac{\{F \times (\mu'_{rm} - 1) + 20\} \times f}{|1 - 0.01 \times \{F \times (\mu'_{rm} - 1) + 10\} \times f^2|}$$

f = Measurement frequency [GHz]

F = $h \ln \frac{c}{b}$ [mm]

h = Height of MUT (material under test) [mm]

b = Inner diameter of MUT [mm]

c = Outer diameter of MUT [mm]

μ' = Measured value of μ'_r

ΔT = Difference of measurement temperature from calibration temperature

ΔT_{max} = Maximum temperature change (°C) at test port from calibration temperature after the calibration is performed.

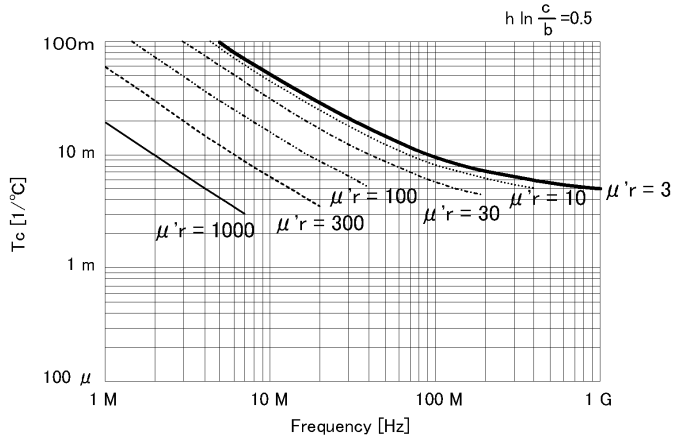

Figure 57. Typical frequency characteristics of temperature coefficient of $\mu'r$ (at $F = 0.5$)

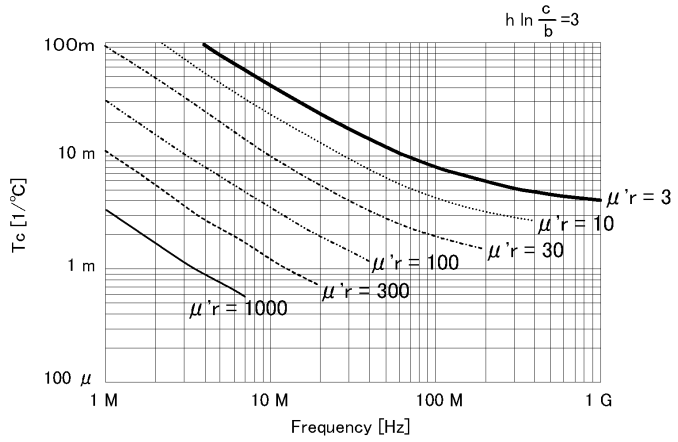

Figure 58. Typical frequency characteristics of temperature coefficient of $\mu'r$ (at $F = 3$)

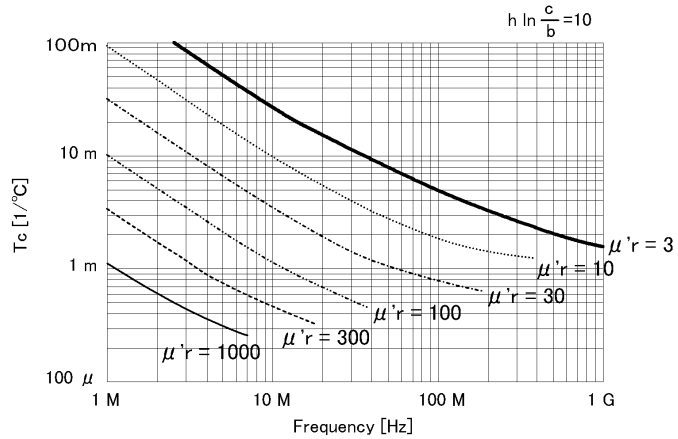

Figure 59. Typical frequency characteristics of temperature coefficient of $\mu'r$ (at $F = 10$)

Agilent Technologies' Test and Measurement Support, Services, and Assistance

Agilent Technologies aims to maximize the value you receive, while minimizing your risk and problems. We strive to ensure that you get the test and measurement capabilities you paid for and obtain the support you need. Our extensive support resources and services can help you choose the right Agilent products for your applications and apply them successfully. Every instrument and system we sell has a global warranty. Support is available for at least five years beyond the production life of the product. Two concepts underlie Agilent's overall support policy: "Our Promise" and "Your Advantage."

Our Promise

Our Promise means your Agilent test and measurement equipment will meet its advertised performance and functionality. When you are choosing new equipment, we will help you with product information, including realistic performance specifications and practical recommendations from experienced test engineers. When you use Agilent equipment, we can verify that it works properly, help with product operation, and provide basic measurement assistance for the use of specified capabilities, at no extra cost upon request. Many self-help tools are available.

Your Advantage

Your Advantage means that Agilent offers a wide range of additional expert test and measurement services, which you can purchase according to your unique technical and business needs. Solve problems efficiently and gain a competitive edge by contracting with us for calibration, extra-cost upgrades, out-of-warranty repairs, and onsite education and training, as well as design, system integration, project management, and other professional engineering services. Experienced Agilent engineers and technicians worldwide can help you maximize your productivity, optimize the return on investment of your Agilent instruments and systems, and obtain dependable measurement accuracy for the life of those products.



Agilent Email Updates

www.agilent.com/find/emailupdates

Get the latest information on the products and applications you select.

Agilent T&M Software and Connectivity

Agilent's Test and Measurement software and connectivity products, solutions and developer network allows you to take time out of connecting your instruments to your computer with tools based on PC standards, so you can focus on your tasks, not on your connections. Visit www.agilent.com/find/connectivity for more information.

By internet, phone, or fax, get assistance with all your test & measurement needs

Phone or Fax

United States:

(tel) 800 452 4844

Canada:

(tel) 877 894 4414

(fax) 905 282 6495

China:

(tel) 800 810 0189

(fax) 800 820 2816

Europe:

(tel) (31 20) 547 2323

(fax) (31 20) 547 2390

Japan:

(tel) (81) 426 56 7832

(fax) (81) 426 56 7840

Korea:

(tel) (82 2) 2004 5004

(fax) (82 2) 2004 5115

Latin America:

(tel) (305) 269 7500

(fax) (305) 269 7599

Taiwan:

(tel) 0800 047 866

(fax) 0800 286 331

Other Asia Pacific Countries:

(tel) (65) 6375 8100

(fax) (65) 6836 0252

Email: tm_asia@agilent.com

Online Assistance:

www.agilent.com/find/assist

Product specifications and descriptions in this document subject to change without notice.

© 2003 Agilent Technologies, Inc.
Printed in USA August 13, 2003
5980-1233E



Agilent Technologies