

**HP 8719C
HP 8720C
HP 8722C
Network Analyzer**

Technical Data

**50 MHz to 13.5 GHz
50 MHz to 20 GHz
50 MHz to 40 GHz**

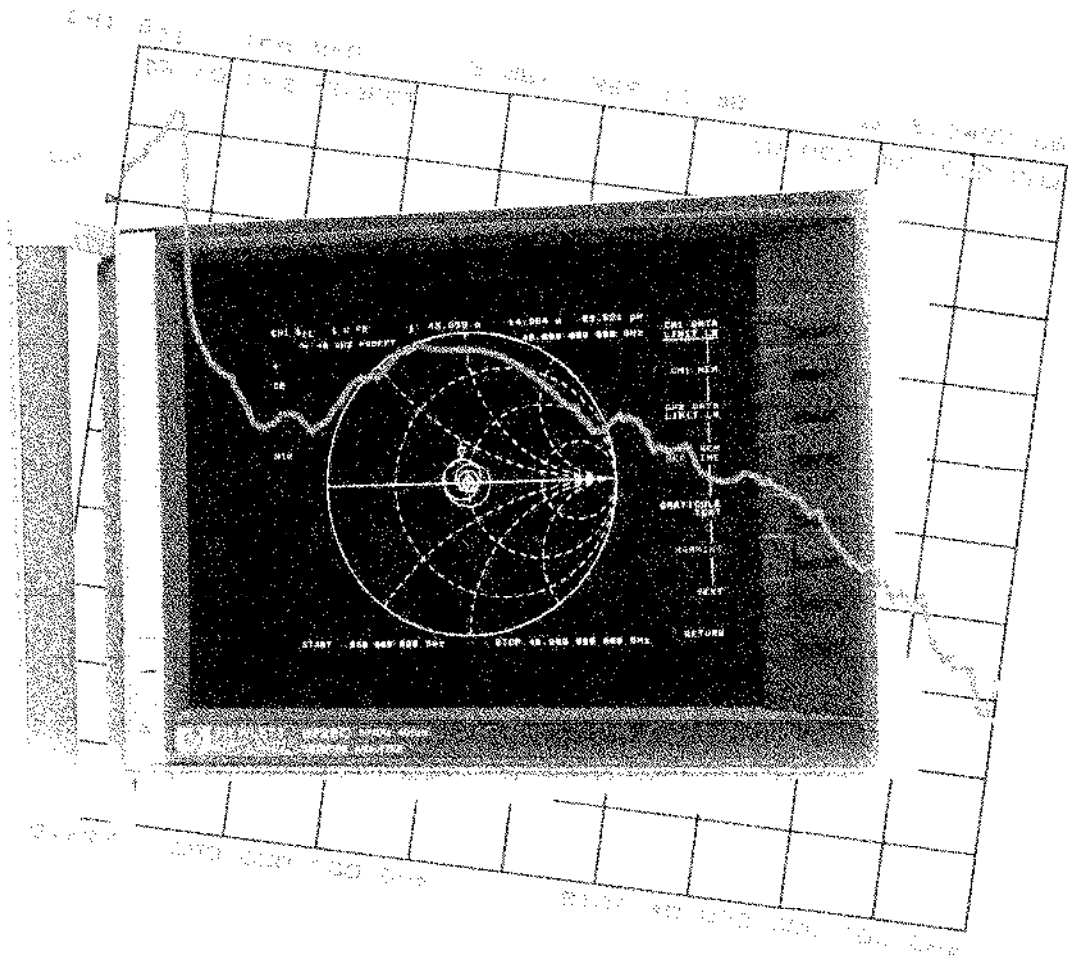

System performance

HP 8719C, 50 MHz to 13.5 GHz

HP 8720C, 50 MHz to 20 GHz

with 3.5mm test ports

Cal kit: HP 85052B 3.5 mm with sliding loads

Cables: HP 85131F 3.5 mm flexible cable set

IF bandwidth: 10 Hz

Averaging: none (except during isolation cal)

Dynamic range

	Frequency range			
	.05-.5	.5-2	2-8	8-20
Maximum receiver power (<0.1 dB compression)	+20 dBm	+13 dBm	+10 dBm	+10 dBm
Maximum source power (at test ports)	+10 dBm	+10 dBm	+10 dBm	+10 dBm
Receiver noise floor (sensitivity)	-65 dBm	-90 dBm	-93 dBm	-93 dBm
Receiver dynamic range	85 dB	103 dB	103 dB	103 dB
System dynamic range	75 dB	100 dB	103 dB	103 dB

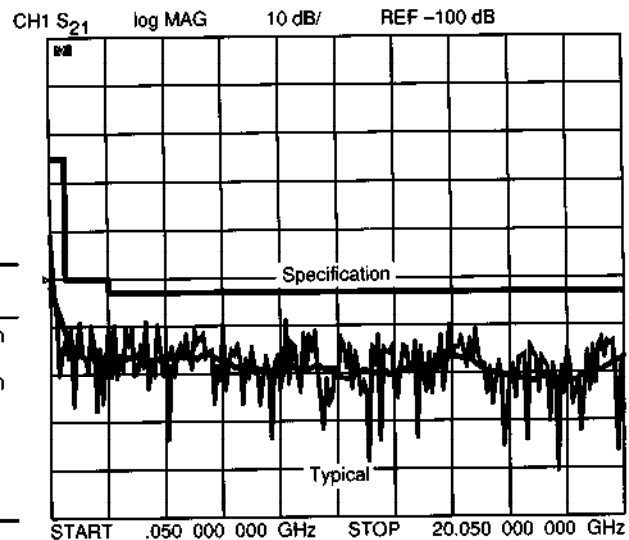

Measurement uncertainty

Reflection measurements

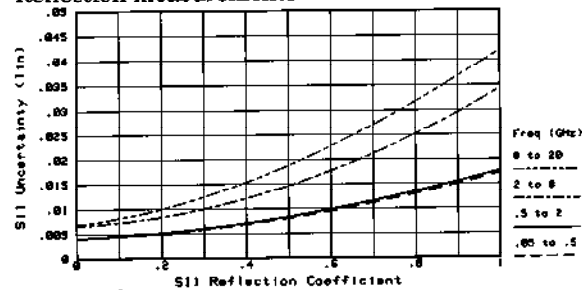

Magnitude

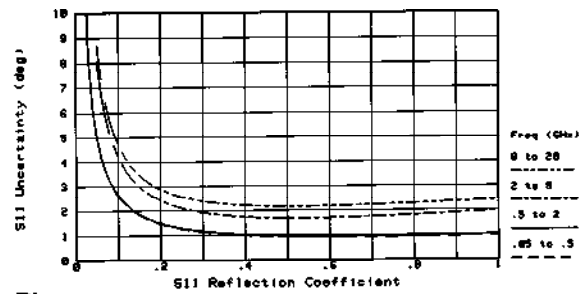

Phase

Transmission measurements

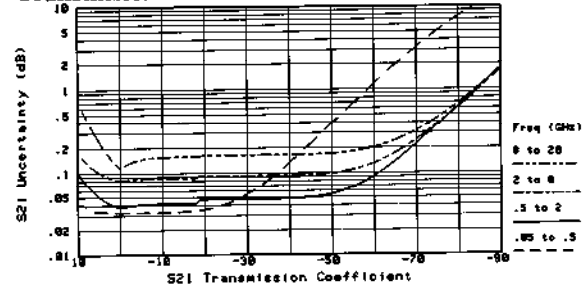

Magnitude

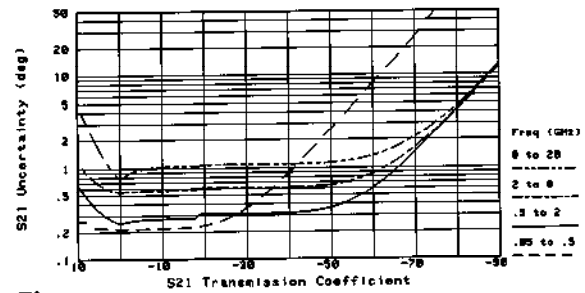

Phase

Measurement port characteristics

Residual	Frequency range (GHz)			
	.05-.5	.5-2	2-8	8-20
Directivity	48 dB	48 dB	44 dB	44 dB
Source match	40 dB	39 dB	32 dB	30 dB
Load match	48 dB	45 dB	38 dB	37 dB
Reflection tracking	0.006 dB	0.010 dB	0.031 dB	0.031 dB
Transmission tracking	0.009 dB	0.016 dB	0.065 dB	0.106 dB

Raw (typical)	Frequency range (GHz)			
	.05-.5	.5-2	2-8	8-20
Directivity	32 dB	32 dB	26 dB	18 dB
Source match	20 dB	18 dB	14 dB	11 dB
Load match	26 dB	24 dB	15 dB	12 dB

System performance

Option 006 (HP 8719C, 8720C)

Description: Option 006 replaces the mechanical test port switch with a solid-state transfer switch that operates in a continuous switching mode.

Cal kit: HP 85052B 3.5 mm with sliding loads
 Cables: HP 85131F 3.5 mm flexible cable set
 IF bandwidth: 10 Hz
 Averaging: none (except during isolation cal)

Dynamic range

	Frequency range			
	.05-.5	.5-2	2-8	8-20
Maximum receiver power (<0.1 dB compression)	+20 dBm	+13 dBm	+10 dBm	+10 dBm
Maximum source power (at test ports)	+5 dBm	+5 dBm	+5 dBm	+5 dBm
Receiver noise floor (sensitivity)	-65 dBm	-90 dBm	-93 dBm	-93 dBm
Receiver dynamic range	85 dB	103 dB	103 dB	103 dB
System dynamic range	70 dB	95 dB	98 dB	98 dB

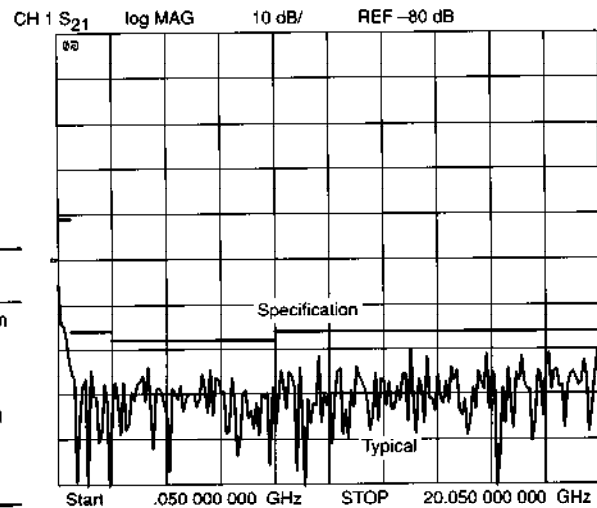

Measurement uncertainty

Reflection measurements

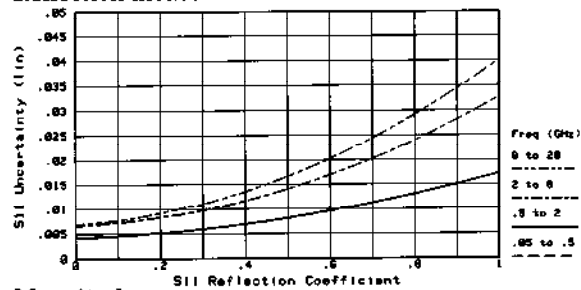

Magnitude

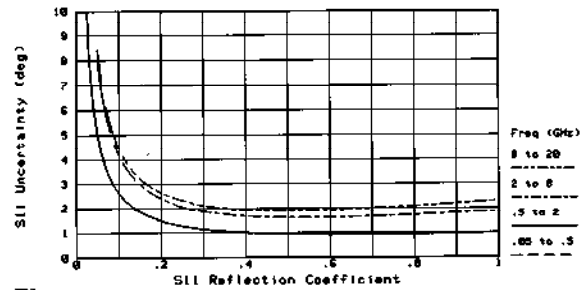

Phase

Transmission measurements

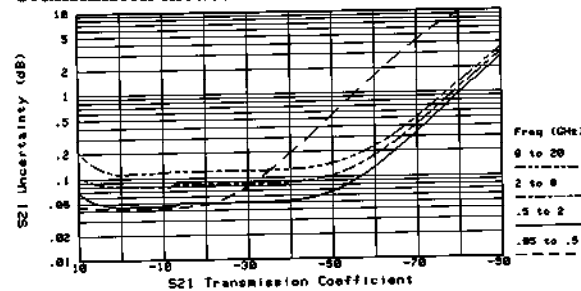

Magnitude

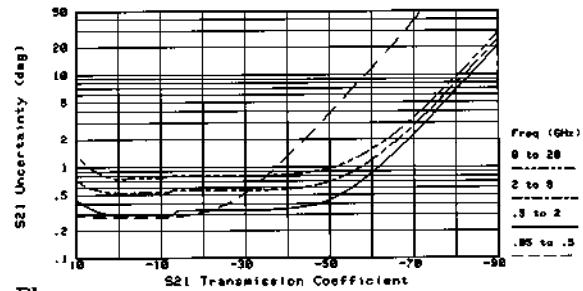

Phase

Measurement port characteristics

Residual	Frequency range (GHz)			
	.05-.5	.5-2	2-8	8-20
Directivity	48 dB	48 dB	44 dB	44 dB
Source match	40 dB	40 dB	33 dB	31 dB
Load match	48 dB	48 dB	44 dB	44 dB
Reflection tracking	0.006 dB	0.006 dB	0.006 dB	0.008 dB
Transmission tracking	0.019 dB	0.021 dB	0.052 dB	0.079 dB

Raw (typical)	Frequency range (GHz)			
	.05-.5	.5-2	2-8	8-20
Directivity	32 dB	32 dB	26 dB	18 dB
Source match	10 dB	10 dB	10 dB	10 dB
Load match	22 dB	20 dB	15 dB	12 dB

System performance

HP 8722C, 50 MHz to 40 GHz
with 2.4mm test ports

Cal kit: HP 85056A 2.4mm with sliding loads

Cables: HP 85133F 2.4mm flexible cable set

IF bandwidth: 10 Hz

Averaging: none (except during isolation cal)

Dynamic range

	Frequency range			
	.05-2	2-8	8-20	20-40
Maximum receiver power (<0.1 dB compression)	+12 dBm	+8 dBm	+8 dBm	+4 dBm
Maximum source power (at test ports)	0 dBm	0 dBm	0 dBm ¹	-5 dBm
Receiver noise floor (sensitivity)				
Standard	-98 dBm	-98 dBm	-93 dB	-92 dBm
Option 003	-107 dBm	-107 dBm	-102 dB	-101 dBm
Receiver dynamic range	110 dB	106 dB	101 dB	96 dB
System dynamic range				
Standard	98 dB ²	98 dB	93 dB ¹	87 dB
Option 003	107 dB	107 dB	102 dB ¹	96 dB

¹ Valid to 26.5 GHz

² Rolls off below 840 MHz to 76 dB at 50 MHz

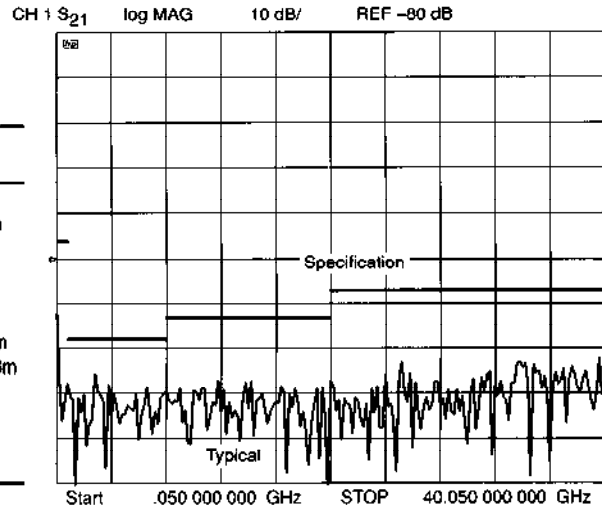

Measurement uncertainty

Reflection measurements

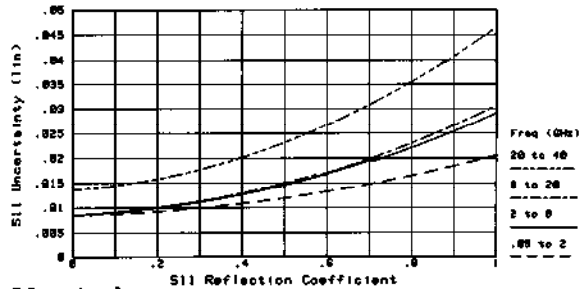

Magnitude

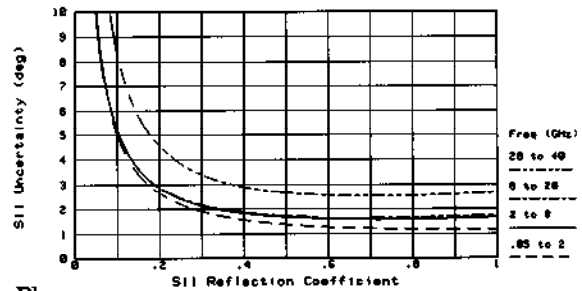

Phase

Transmission measurements

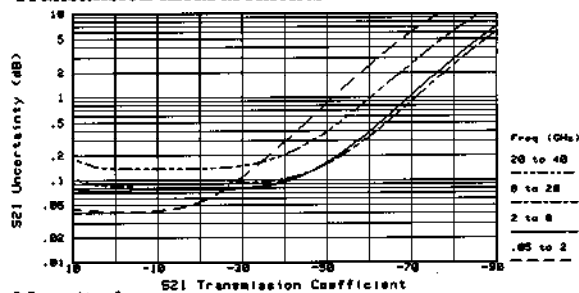

Magnitude

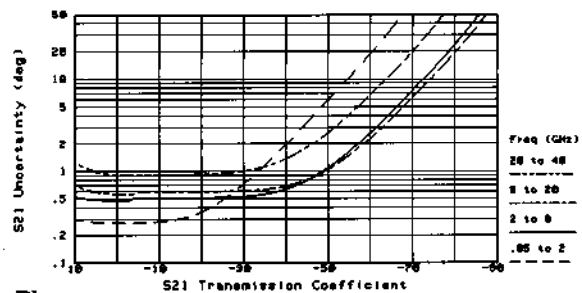

Phase

Measurement port characteristics

	Frequency range			
	.05-2	2-8	8-20	20-40
Residual				
Directivity	42 dB	42 dB	42 dB	38 dB
Source match	40 dB	35 dB	34 dB	31 dB
Load match	41 dB	38 dB	37 dB	35 dB
Reflection tracking	0.011 dB	0.037 dB	0.039 dB	0.047 dB
Transmission tracking	0.017 dB	0.052 dB	0.075 dB	0.130 dB

	Frequency range (GHz)			
	.05-2	2-8	8-20	20-40
Raw (typical)				
Directivity	20 dB	20 dB	20 dB	20 dB
Source match	20 dB	15 dB	12 dB	8 dB
Load match	23 dB	18 dB	14 dB	12 dB

System performance (typical)

HP 8722C, 50 MHz to 40 GHz
with 2.92mm (K-connector) test ports

Cal kit: HP 85056K Option 001 2.4mm with sliding loads (apply 2.92mm adapters from HP 85056K or 11904S after 2.4mm calibration)
Cables: HP 85133F 2.4mm flexible cable set
IF bandwidth: 10 Hz
Averaging: none (except during isolation cal)

Dynamic range

Same as HP 8722C with 2.4mm connectors.

Measurement uncertainty

Reflection measurements

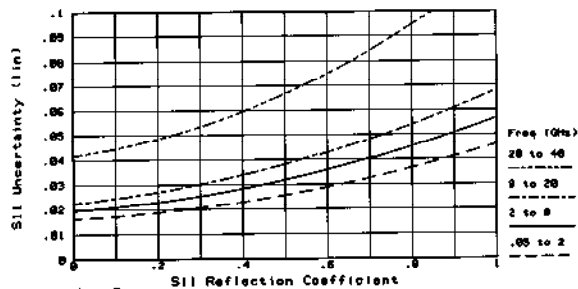

Magnitude

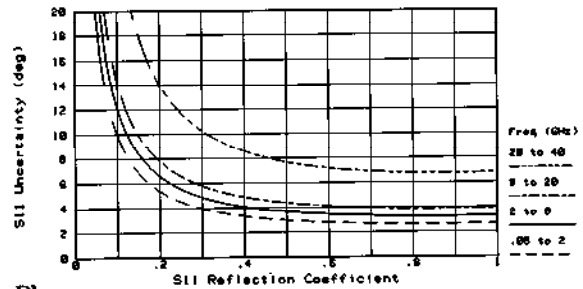

Phase

Transmission measurements

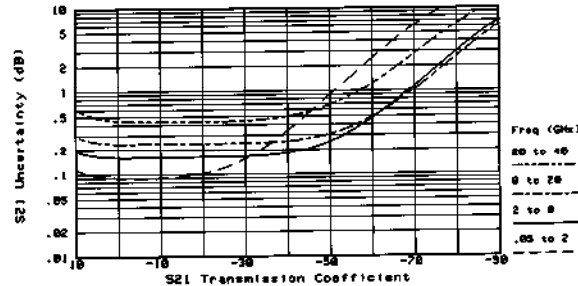

Magnitude

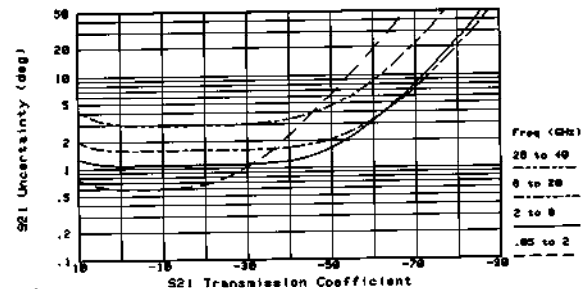

Phase

Note: System performance in 2.92mm (K) connectors is provided to indicate typical uncertainty using 2.92mm adapters after 2.4mm calibration. Performance is not verifiable due to lack of traceable standards in K-connectors. These curves indicate worst-case sums of errors; typical uncertainties are less than half the values indicated.

System performance

Option 011 (HP 8719C, 8720C, 8722C)

Description: Option 011 allows direct access to the R, A, and B samplers and receivers. The user may measure A, B, R, A/R, B/R, or A/B; only ratios are valid for phase measurements. The transfer switch, couplers, and bias tees are removed. External accessories are therefore required to make most measurements.

Phase locking: a sample of the source output between -10 and -33 dBm must be provided to the R input for phase-locking. This may come directly from the R output provided, or from an external coupler or splitter in the source output chain.

Bias: no DC bias may be applied to any input, so external DC blocks (or bias tees) must be added if center conductors carry a bias voltage.

Low level noise defined as mean of receiver noise (signal/noise ratio of unity) with ports terminated by 50 ohms. Levels are adjusted for typical sampler conversion gain, as if a response calibration to a known power level had been established.

Noise floor is statistically defined as a level over 3σ (standard deviations) above mean of the noise trace. A signal at this level has a signal/noise ratio of at least 10 dB. There is a high probability that noise "peaks" are below the noise floor.

Source output characteristics: same as standard product

High level noise: same as standard product

Connectors: 3.5mm (f) for HP 8719C and 8720C; 2.4mm (f) for HP 8722C

Summary of capabilities

	Frequency range			
	.05-2	2-6	6-20	20-40
Maximum input (<0.1 dB compression)	-4 dBm	-6 dBm	-10 dBm	-17 dBm
Low level noise (S/N=1)	-106 dBm	-102 dBm	-100 dBm	-90 dBm
Receiver dynamic range	112 dB	106 dB	100 dB	88 dBm
Port match	19 dB	17 dB	15 dB	11 dB
Tracking	± 0.4 dB	± 0.8 dB	± 1.0 dB	± 3.0 dB

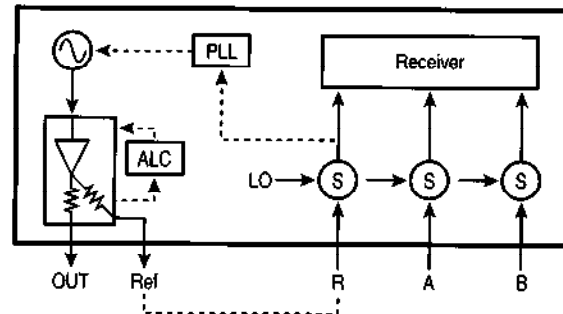

Dynamic Accuracy:

The following plots illustrate worst case magnitude and phase uncertainty due to IF residuals and detector inaccuracies. Excludes uncertainty due to frequency response, isolation, port match and connector repeatability.

A, B channel measurements¹

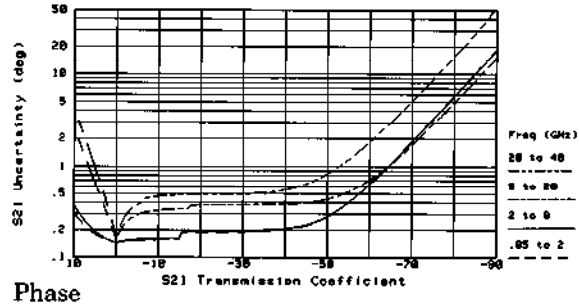
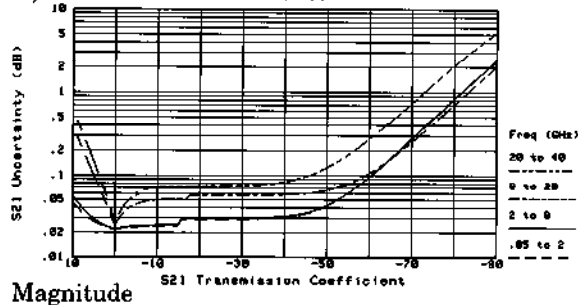

¹ Reference power level is -5 dBm into the test port.

Capabilities

- ◊ Indicates new capabilities over HP 8719A and 8720B
- ⇒ Indicates new capabilities and changes from the HP 8722A

Measurement

Number of channels: 2; each fully independent

Parameters:

- S11: Forward reflection (input match)
- S21: Forward transmission (insertion loss/gain/phase)
- S12: Reverse transmission (reverse isolation)
- S22: Reverse reflection (output match)
- AUXILIARY INPUT: DC voltage on AUX INPUT
- A, B, R, A/R, B/R, A/B (for Option 011)

Parameter conversion: 1-term

- Z - Reflection: equivalent parallel impedance
- Y - Reflection: equivalent parallel input/output admittance
- Z - Transmission: equivalent series impedance
- Y - Transmission: equivalent series admittance
- 1/S: complex inverse of S-parameters

Display formats:

Reflection: linear magnitude (reflection coefficient, rho); log magnitude (return loss or match in dB); SWR or VSWR (voltage standing wave ratio); phase; polar (complex reflection coefficient, Γ); Smith chart (complex impedance); inverse Smith chart (complex admittance)

Transmission: linear magnitude (transmission coefficient, τ); log magnitude (insertion loss/gain in dB, power in dBm); phase (insertion phase, deviation from linear phase, electrical length); group delay (transit time, τ_g , $-\Delta\phi/360^\circ\Delta f$); polar (complex transmission coefficient)

Tabular display formats: lists numeric values, one line per stimulus point; up to 5 columns of data (depending on format, dual-channel, and limit test status): stimulus, data (using current format) and margin (difference between data and nearest limit line) for each channel, and PASS/FAIL indicator; 30 points per screen

Instrument modes: network analyzer (normal); tuned receiver (receiver is set to a fixed frequency to downconvert signal from an external synthesized source with time-base locked to HP 8720)

High-level trace noise (typical):

IF bandwidth	Magnitude (dB zero-peak)	Phase (deg zero-peak)
3000	0.1	0.6
1000	0.04	0.25
300	0.015	0.08
100	0.006	0.04
30	0.004	0.02
10	0.003	0.015

Phase resolution (typical): 0.3 deg (for input of constant amplitude)

Group delay: computed by from the phase change over a frequency interval

$$\text{Group Delay} = \frac{-\Delta\phi}{360^\circ \times \Delta f}$$

Range: limited to 5 μs standard or 500 ms with Option 001
Range = 1/(2 * Aperture_{min})

Aperture: variable frequency interval over which group delay is computed; small apertures show response details but may be noisy; large apertures yield less noise but “smooth” details

$$\text{Aperture}_{\min} = \frac{F_{\text{span}}}{(\text{number-of-points} - 1)}$$

(limited to 100 kHz standard or 1 Hz with Option 001)

$$\text{Aperture}_{\max} = 20\% \text{ of } F_{\text{span}}$$

(limited such that $\Delta\phi < 180^\circ$)

Accuracy: function of uncertainty in determining phase change; typically

$$\text{Delay Uncertainty} = \frac{\pm 0.003 \text{ (Phase Uncertainty in deg)}}{\text{Aperture in Hz}}$$

Markers

Number of markers: 5 per channel; 1 “active” per channel; can be coupled (same stimulus in both channels) or uncoupled (independent stimulus in each channel)

Displayed marker values: all activated markers with both stimulus and response values are displayed on CRT; with dual-channel uncoupled, can display up to 10 markers; all but active marker replaced by bandwidths or statistics, when enabled

Stimulus resolution: discrete (actual measurement points) or continuous (linearly interpolated between points, with 100 kHz resolution standard or 1 Hz with Option 001)

Delta markers: displays difference in both stimulus (e.g. frequency) and response (e.g. dB) between active marker and reference marker; reference marker may be any of five markers, or a sixth fixed marker given any arbitrary position on display

Polar format markers: linear magnitude and phase; log magnitude (dB) and phase; real and imaginary Smith chart format markers: Linear magnitude and phase; log magnitude (dB) and phase; real and imaginary (R+jI); complex impedance (R+jX); complex admittance (G+jB)

Search: finds maximum, minimum, or target value

◊ **Bandwidth:** finds and displays center frequency, bandwidth at a user-defined level (e.g. -3 dB), Q factor, and shape factor (ratio of 60 dB and 6 dB bandwidths); updates while tuning with tracking enabled; valid for band-pass or band-reject (notch) filters

Statistics: calculates and displays mean, standard deviation, and peak-to-peak deviation of trace; active between two markers or over entire trace

Tracking: performs new search (min/max/target) at end of each sweep; if disabled, occurs once on demand

Marker-To Functions: active marker stimulus to start, stop, or center; active and delta marker to stimulus span; active marker response to reference value; active marker to delay (sets electrical delay to remove linear portion of phase response)

Source frequency characteristics

Range

	HP 8719C	HP8720C	HP 8722C
Minimum frequency	50 MHz	50 MHz	50 MHz
Maximum frequency	13.51 GHz	20.05 GHz	40.05 GHz

Frequency resolution: 100 kHz (standard); 1 Hz with Option 001; accuracy and stability not affected by Option 001; see table below

	Standard	Option 001
Source resolution (start, stop, center, span)	100 kHz	1 Hz
Marker resolution	100 kHz	1 Hz
Minimum span at 101 points	10 MHz	100 Hz
Minimum span at 201 points	20 MHz	200 Hz
Maximum time domain range	10 μ s	1 s
Maximum group delay range	5 μ s	500 ms
Minimum group delay aperture	100 kHz	1 Hz

Frequency accuracy: 10 ppm at 23° \pm 3°C (can be locked to external frequency reference)

Frequency stability (typical):

\pm 7.5 ppm over 0° to 55°C (temperature)
 \pm 3 ppm per year (aging)

Control: set start/stop or center/span

Number of points: 3, 11, 21, 51, 101, 201, 401, 801, 1601

Sweep types:

Linear

Log (not valid for less than 4:1 bandwidth)

Arbitrary frequency list: define up to 30 different subsweep frequency segments; in any combination of CW, start/stop, or center/span modes; arbitrary number of points up to 1601 points total; overlapping or nested subsweeps allowed
CW time: fixed source frequency, with time as horizontal axis

Power sweep: sweep power level, at a CW frequency

Source coupling: coupled (same frequency range in both channels) or uncoupled (independent for each channel, for "alternate sweep" mode)

Sweep time: manual or automatic (uses fastest possible sweep time for given frequency range, number of points, etc)

Sweep trigger: continuous, hold, single sweep, group (1 to 999 sweep sets), external trigger of entire sweep

Single point trigger: external or manual (button) trigger to acquire single point of multi-point sweep; compatible with any sweep type

Sweep modes:

Synthesized sweep: smooth linear sweep ramp (in each band); frequency fully and continuously synthesized at all times; data acquired "on the fly"

Synthesized step: frequency is fixed while acquiring data, then ramps to next point; dwell time adjustable via manual sweep time; user-selectable, or automatically activated by sweep time of >15 ms per point, list frequency mode, or bandwidth of 10 or 30 Hz

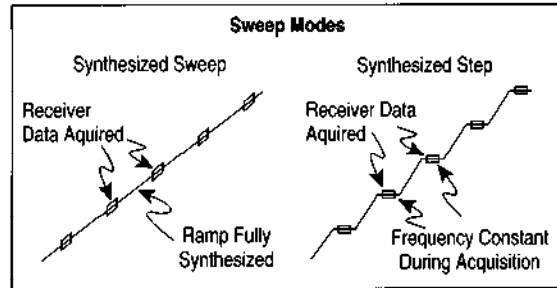

Spectral purity (typical):

Harmonics: <-15 dBc at +10 dBm

Phase noise: <-35 dBc to 60 kHz from carrier

Spurs: <-40 dBc at 100 kHz

<-50 dBc at 200 kHz

<-65 dBc at >200 kHz

Source power characteristics

Power range:

	HP 8719C	HP8720C	HP 8722C
Maximum power (below 26.5 GHz)	+10 dBm ¹	+10 dBm ¹	-5 dBm ²
Minimum power	-65 dBm ¹	-65 dBm ¹	-60 dBm
Resolution	0.05 dB	0.05 dB	0.05 dB
Flatness	\pm 2 dB	\pm 2 dB	\pm 3 dB

¹ For Option 006, lower power values by 5 dB.

² For Option 003, lower port 2 power by approximately 15 dB coupler roll-off.

Power sweep: continuous in ranges staggered by 5 dB

	HP 8719C	HP8720C	HP 8722C
Range	20 dB	20 dB	15 dB
Linearity	\pm 0.5 dB	\pm 0.5 dB	\pm 0.5 dB
Linearity (<5 dB sweep)	\pm 0.2 dB	\pm 0.2 dB	\pm 0.2 dB

Power accuracy: \pm 0.5 dB at 50 MHz at maximum power

Power meter calibration: improves output power accuracy and flatness, referenced to HP 437B or 438A power meter; network analyzer controls power meter directly during calibration sweep, then corrects power level at fast sweep rate

Test ports: NMD-3.5mm male (ruggedized) for HP 8719C and 8720C; NMD-2.4mm male (ruggedized) for HP 8722C; not included in Option 011; 50 ohm nominal impedance

Calibration (vector error correction)

Calibration types:

Response: 1-term; corrects for frequency response (magnitude and phase), for either reflection or transmission

Response/Isolation: 2-term; for reflection, corrects for frequency response and directivity; for transmission, corrects for frequency response and crosstalk

1-port: 3-term; corrects for frequency response, directivity, and source match; used for 1-port reflection only, S_{11} or S_{22}

Full 2-port: 12-term; standard are short, open (or offset short), load, and thru; corrects for reflection frequency response, directivity, source match, transmission frequency response, load match, and crosstalk

- ⊖ *Fast 2-port*: 12-term; similar to full 2-port, except that 2 of 4 raw parameters (forward or reverse) are continuously re-measured while remaining 2 are assumed constant; improves update rate for tuning, and reduces unnecessary wear on transfer switch; MEAS key causes full 2-port update
- ⊖ *Offset load*: 3-term; standards are short, offset short, load, and offset load; used for 1-port reflection only, S_{11} or S_{22}
- ⊖ *TRL* (Thru-Reflect-Line)*: 12-term; reference plane set by choice of thru (center if non-zero length) or reflects; system impedance set by choice of line (actual dispersive impedance) or user-defined system Z_0 ; (3-sampler implementation has performance different from HP 8510, since match terms are not fully corrected)
- ⊖ *LRM* (Line-Reflect-Match)*: 12-term; similar to TRL*, but uses termination at each test port in place of longer line

Internal calibration kits:

3.5 mm (HP 85052B or 85052D, fixed or sliding loads)

7 mm (HP 85050B or 85050D, fixed or sliding loads)

Type-N (HP 85054B or 85054D, fixed or sliding loads)

- ⊖ *TRL*/LRM** (template for user modification)
 - ⊖ 2.4 mm (HP 85056A or 85056D) (HP 8722C only)
 - ⊖ 2.92 mm (*K-connector*) (HP 85056K) (HP 8722C only, based on use of adaptors to 2.92 mm after 2.4 mm calibration)
- User calibration kit*: load from disk drive, copy from internal kits and modify, or define custom kits; allows up to 8 standards in either coax or waveguide (dispersive)
- Segmented cal**: calibration remains valid for any frequency segment (in frequency list mode), after calibrating all segments with a single cal
- Frequency subset (“zoom”) cal**: calibration remains valid despite changes to frequency range; new range must be subset of frequency range of calibration; analyzer measures over cardinal calibration points (i.e. adjusts number of points, without interpolation)
- ⊖ **Receiver power cal**: adjusts non-ratio’ed receiver inputs to absolute (non-ratio’ed) power level; displays absolute power in dBm; requires reference sweep of known source power

Data averaging (noise reduction):

IF bandwidth: point-to-point averaging; bandwidths include 10, 30, 100, 300, 1000, and 3000 Hz; each factor of 10 reduces noise by 10 dB

Averaging: sweep-to-sweep averaging; averaging factors range from 1 to 999; each increase by factor of 2 reduces noise by 3 dB

Smoothing: moving average of adjacent formatted data points (similar to video filtering); aperture “window” adjustable from 0.1% to 20% of trace width

Electrical delay: add or subtract delay (linear phase slope), up to $\pm 10 \mu\text{s}$; similar to “line stretchers”; both coax or waveguide (dispersive) modes; secondary readout in distance, computed from velocity factor

Reference plane extension: add or subtract delay (linear phase slope) to each port, up to $\pm 10 \mu\text{s}$; similar to electrical delay, but applied appropriately to each of four parameters

Velocity factor: used to relate time to distance in secondary readouts

System Z_0 : nominally 50 ohms; adjustable from 0.001 to 1000 ohms; impacts marker impedance displays and arbitrary impedance or offset during calibration

↪ Continuous Switching:

option 006 only; continuously switches the RF output between port 1 and port 2; enables simultaneous active display of forward and reverse parameters; eliminates the need to press MEAS to update measurement data when using full 2-port cal

Data acquisition modes:

Alternate: acquire one parameter per sweep; requires 4 sweeps for full 2-port measurements; greater sensitivity (less crosstalk) than chopped

- ⊖ *Chop*: acquire two parameters per sweep; needs only 2 sweeps for full 2-port measurements; twice as fast as alternate

Display control

Display type: color raster

Colors: default or user-defineable; 100 colors; 100 tints; assigned to 7 groups of display elements

Screen formats: single channel; dual channel overlay (both traces at maximum size); or dual channel split (separate graticules, top and bottom)

Trace memories: 2 (1 per channel)

Trace control: display current data, memory, or both

Trace math: display vector ratio (DATA/MEM) or difference (DATA-MEM)

Autoscale: automatically adjusts reference value and scale/division to put entire trace on screen

Limit lines: define up to 22 test limit segments per channel; segments may be any combination of flat lines, sloping lines, or discrete points (both upper and lower); limit testing gives PASS/FAIL decision on each sweep

Save/Recall storage

Internal registers: save/recall up to five instrument states and 12 calibration sets (different for each parameter); may be given user-defined 8-character labels

- ⇒ **Memory type:** 240 kBytes of non-volatile CMOS RAM; backed up by “super-capacitor” with 14 day life (typical); dynamically allocated; large enough to store all five registers with 12-term error correction and memory traces in each channel at 401 points
- ⇒ **User Preset:** register 5 reserved for user-definable power-up or USER PRESET (green key) state; if empty, factory preset conditions are used

External disk drive: store/load to external disk drive via HP-IB

Disk format: LIF (HP’s Logical Interchange Format); recommend HP 92192A double-sided 720 kByte (gray) disks; yields 616 kBytes of useable storage; can be translated to MS-DOS® disk format using HP E2080A LIFUTIL on any MS-DOS PC; Hierarchical File System (HFS) not compatible with hard drives

Compatible disk drives: disk drives using command subset CS/80 or subset SS/80 protocol

Recommended disk drives:

HP 9122C dual 3.5 inch disk drive
HP 9153C Option 020 20 MByte hard disk with 3.5 inch disk drive

Disk transfer rate (typical): 5 seconds (201 points, no cal); 15 seconds (1-port cal); 40 seconds (2-port cal)

Data formats:

Binary: 64-bit IEEE-754 floating point format
ASCII: using CITIFile convention; compatible with HP’s Microwave Design System; includes all four parameters in single file if using 2-port error correction

Register names: user-definable; <8 characters

Disk file names: multiple files stored on disk for each data type enabled; file name shares root register name, plus unique 1-2 character suffix for each data type

Data types stored:

Instrument state (learn string): all variables defining the analyzer’s settings; binary only; file suffix I
User cal kit: included with disk store if User Kit is active cal kit; binary only; file suffix K
User graphics: binary only; included in disk store if enabled; file suffix Gn

Raw data (uncorrected): included with disk store if enabled; must be stored (with cal arrays) to perform later time domain analysis; file suffix Rn

Data (corrected): included with disk store if enabled; if loaded from disk, puts analyzer in HOLD to prevent erasing data; file suffix Dn

Formatted: corrected data after formatting (e.g. log mag, phase, etc); included with disk store if enabled; file suffix Fn

Memory (“trace memory”): 2 maximum, 1 per channel; ~6 Bytes/point; included with disk store if MEM is displayed; file suffix Mn

Calibration arrays (“cal sets”): 12 maximum, or up to 5 full 2-port calibrations; linked to registers, and to parameters within register (except for full 2-port, which applies to all four parameters); ~6 Bytes/point per error term; included with disk store if correction is on; file suffix nn

Data hardcopy

Plot: copies graphical CRT image (excluding softkey labels) to compatible plotter

Plotting time (typical): 50 seconds (PRESET state with HP 7470A)

Print: copies graphical display image (excluding softkey labels) to compatible graphics printer; supports color printer graphics

Buffer: stores one plot or print, and controls peripheral while returning front panel control to user

Buffer loading time (typical): 2 seconds

Disable buffer: put instrument in HOLD for fastest plotting

Aborting plots or prints: press LOCAL key at any time

Tabular: lists numeric data to compatible printer (or plotter); one line per stimulus point, with up to five columns defined by currently active parameters

Recommended plotters and printers:

HP 7090A measurement plotting system
HP 7440A Option 002 ColorPro plotter
HP 7475A Option 002 6-pen graphics plotter
HP 7550B high performance plotter
HP 2225A ThinkJet graphic printer
HP 2227B QuietJet graphics printer
HP 3630A Option 002 PaintJet color graphics printer

Time domain (Option 010)

Stimulus modes:

Low-pass step: simulates step function, similar to traditional Time Domain Reflectometer (TDR); provides distinct response for each type of impedance (R, L, or C); useful for reflection measurements; requires device with low-pass response

Low-pass impulse: simulates pulse function (derivative of step); provides magnitude information only; meaningful for both reflection and transmission; requires device with low-pass response

Bandpass impulse: simulates pulse function; provides magnitude information only; meaningful for both reflection and transmission; useable on most devices with band-pass response

Frequency requirements: low-pass modes require harmonically related frequency points, with points at 0 Hz (DC) and 25 MHz extrapolated from low-frequency data; linear and CW-time sweep modes only

- Number of points: low-pass modes allow up to 801 points maximum; no limit in band-pass mode.

Time domain range: maximum time/distance free of aliasing (false duplicated responses); limited in low-pass modes by 25 MHz minimum frequency spacing; limited to 10 μ s without Option 001; given by:

$$\text{Range} = \frac{(\text{Number-of-Points} - 1)}{F_{\text{span}}}$$

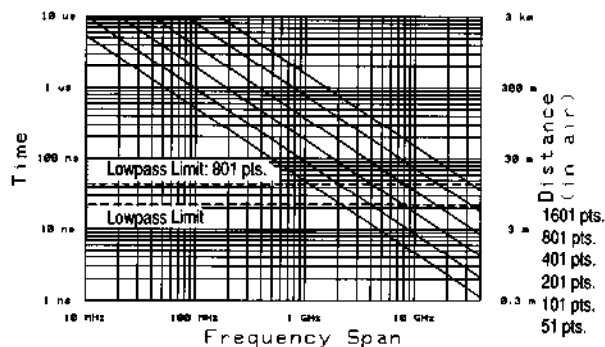

Response resolution: minimum difference in time/distance between two equal responses that can be resolved

$$\text{Response Resolution} \approx \frac{1}{F_{\text{span}}}$$

Distance: related to time by speed of light and relative velocity; in space, $V_{\text{rel}}=1$; for TEM wave in dielectric, $V_{\text{rel}}=1/\sqrt{\epsilon}$; for distance to response in reflection measurement, multiply by 1/2

$$\text{Distance} = 3 \times 10^8 \frac{\text{m}}{\text{SEC}} \times V_{\text{rel}} \times \text{Time}$$

Windows: pre-filtering in the frequency domain to enhance time domain response; continuously variable, plus minimum, normal, and maximum settings

Gating: time domain filters to remove unwanted responses separated in time; capable of bandpass and band-reject (notch) operation; set with start/stop or center/span controls

Measurement throughput summary

(based on 50 MHz to 20 GHz sweep with 3 kHz IF bandwidth, including system retrace time and all source band changes; 2-port times based on chop mode)

Measurement time (ms) versus number of points (typical):

Measurement	3	51	101	201	1601
1-port (3-term)#	350	465	485	530*	1300
Fast 2-port	390	565	735	1000	5270
Full 2-port	660	910	1035	1265	6200
Time domain conversion	15	180	300	540	2840
HP-IB data transfer					
1: Binary	10	28	40	62	450
2: 32-bit	12	48	80	160	1180
3: 64-bit	15	65	120	235	1790
4: ASCII	40	480	940	1860	14700
5: 32-bit PC	12	48	86	165	1260

Measurements with no error correction, response, or response/isolation calcs are similar.

*Reference used for following comparisons.

Measurement time versus sweep mode (typical):

Sweep Mode	Time (ms)
Linear	530
Log	1250
List	1250
CW time	170
Power	890

Measurement time versus frequency span (typical):

Frequency range	Time (ms)
0.05 to 20 GHz	530
5 to 15 GHz	280
8 to 12 GHz	275
9 to 11 GHz	245

Measurement time versus IF bandwidth (typical):

IF bandwidth	Time (ms)
3000	530
1000	660
300	1100
100	2400
30	7500
10	22000

Measurement time versus averaging (typical):

multiply by averaging factor

Measurement time in CW external trigger on point (typical): <3ms/point (based on 1601 points, zero span, excluding phase lock and HP-IB transfer)

HP-IB (remote) programming

Interface standards: IEEE 488.1 and IEC 625

Interface modes:

System controller: analyzer is only controller on bus; takes direct control of plotter, printer, or disk drive

Talker/listener: analyzer responds to a controller on bus; can not talk to peripherals

Pass control: analyzer shares bus with another controller, and requests active control when needed to control peripherals; controller must be programmed to pass and receive active control

Data arrays available via HP-IB:

Raw (uncorrected) data

Calibration arrays (error coefficients)

Corrected data

Memory

Formatted data

Array transfer data formats:

1: *Binary (internal)*

2: *32-bit floating point (IEEE-754)*

3: *64-bit floating point (IEEE-754)*

4: *ASCII*

5: *32-bit floating point (PC-compatible reversed bytes)*

User graphics: write vector or text graphics to display via HP-IB; uses a subset of HP-GL commands; 64 kBytes maximum

Interface function codes: SH1, AH1, T6, L4, SR1, RL1, PP0, DC1, DT1, C1, C2, C3, C10, E2

Compatibility: HP-IB programming commands for HP 8719C, 8720C, and 8722C are complete superset of commands for HP 8719A, 8720A, 8720B, and 8722A; commands are ~95% compatible with HP 8753 family and ~85% compatible with HP 8510 family

Upgrades

Refer to Ordering Guide.

Security

Frequency blank: blanks all frequency information from display, including markers; requires FACTORY PRESET to re-enable.

- ⊞ **Reset memory:** writes binary 0s to all non-volatile memory registers, erasing all instrument state and calibration data; used with PRESET

Rear panel connectors

BIAS CONNECT: DC bias input to internal tees, one for each port; internally fused to 500 mA maximum; 40 Vdc maximum

EXT REF IN: external frequency reference input, to which network analyzer locks its internal timebase; external reference must have following characteristics:

Frequency: 1, 2, 5, or 10 MHz; ±200 Hz maximum

Level: -10 to +20 dBm

Impedance: 50 ohms

EXT TRIGGER: external trigger input, activated on negative TTL transition (+5 to 0V); internal 10 k-ohm pull-up resistor allows use of contact closure to ground; input can trigger three functions:

Sweep: begins entire sweep when armed

- ⊞ *Point:* acquires single data point of multi-point sweep

EXT AM: external AM input; 0 to +10 V into 100 k ohm; approximately -2 dB/volt sensitivity; 1 kHz maximum

AUX INPUT: auxiliary voltage input; -10 to +10 V; can be measured with “analog bus” and displayed as voltage on vertical axis in real format

IO INTERCONNECT (DB-25):

pin 17: limit test output; LS TTL, +5V=pass, 0V=fail

pin 14: +22 Vdc power supply output

pin 8: transfer switch output; LS TTL, +5 V=forward, 0 V= reverse

EXT MON (RED/GREEN/BLUE): video outputs to drive external monitors with the following characteristics:

Format: RGB (red/green/blue) with sync on green

Impedance: 75 ohms

Horizontal scan rate: 25.5 kHz

Refresh rate: 60 Hz

Level: 1 Vp-p

Compatible monitors:

HP 35731A/B monochrome monitor

HP 35741A/B color monitor

Most other analog multi-sync monitors

REF IN, REF OUT: reference link out/in, between reference power splitter and reference (R) sampler; user may add electrical length to “balance” test set for faster measurements on long devices, without IF shift distortion; not included in Option 011

Environmental

- ⊞ **Keyboard:** flexible membrane; sealed against air flow and dust

Operating temperature: 0° to 55°C

Storage temperature: -40° to 75°C

Line power:

Frequency: 47.5 to 66 Hz

Voltage: 115Vrms, -25% to +10%; or 230Vrms, -15% to +10%

Power: 220 volt-amperes maximum

Weight: 34 kg (75 lb) net; 40 kg (88 lb) shipping

Dimensions:

Height: 267 mm (10.5 inches)

Width: 425 mm (16.75 inches)

Depth: 502 mm (19.75 inches)

Ventilation: allow 100 mm (4 inches) around rear and sides

Software

HP 85162A Measurement Automation Software

Description: This software is designed specifically to operate on an HP 9000 Series 200 or 300 computer for automation of the HP 8519C, 8720C, or 8722C network analyzer. The software complements the hardware, providing calibration, measurement, and data output capabilities with a minimum of operator interaction. Measurement data can be stored in binary format or in a data file compatible with many CAE design programs.

Performance summary

Measurements (vs frequency): Insertion loss, gain, return loss, impedance, reflection coefficient, SWR, phase, and group delay.

Source stimulus modes:

Start, stop, number of points (1601 points max.)
Center, span, number of points (1601 points max.)
Frequency list (30 frequency segments max, 1601 points max)

Source power level, sweep time, IF bandwidth, averaging factor, smoothing, and electrical delay, are also supported. All supported settings can be stored in program configuration files.

Calibration kits: 7 mm, 3.5 mm, 50 Ω type-N, 2.4 mm, waveguide bands

Calibration types: S11-1 port, full 2-port, response/isolation, and reponse cal methods

Required equipment

HP 9000 Series 200 or 300 computer with the following:
BASIC Operating System (5.0 or higher)
RAM memory (including BASIC): 2 Mbytes
HP 9122C Dual Disc Drive (not required for HP 9836A/C)

Optional equipment

Plotter: HP 7470A Opt. 002, 7475A Opt. 002, 7440A Opt. 002, 7090A Opt. 002, or 7550A

Printer: HP ThinkJet, QuietJet, DeskJet and LaserJet series

Winchester hard disc drive: HP 9153C, 7957B, 7958B, 7959B

HP 85071A Materials Measurement Software

Description: The HP 85071A software takes broadband S-parameter measurements of dielectric and magnetic materials and determines their electromagnetic properties. The software calculates both the complex permittivity ϵ_r (or dielectric constant) and permeability μ_r , including loss factors. Depending on the network analyzer and fixtures used, measurements can extend from below 500 MHz to 110 GHz. The software offers the choice of four algorithms, each designed to address specific measurement needs.

Operating requirements

Standard: Requires MS-DOS on an HP Vectra (or any 100%-compatible PC-AT computer) compatible with Microsoft Windows 3.0 with mouse. Requires >20 Mbyte hard disk and >640 Kbytes RAM.

Option 300: Substitutes HP BASIC Software for the standard version for operation with HP 9000 series 300 controllers. Requires BASIC 5.0 or higher and 2 Mbytes of RAM.

Performance summary

Frequency range: 100 MHz to 110 GHz (typical, depending on network analyzer, fixture, and material).

Measurements (vs. frequency): ϵ_r' , ϵ_r'' , μ_r' , μ_r'' , $\tan \delta$, or $\tan \delta_m$ in linear format. Accuracy is 1 to 2% typical.

Stimulus control: Frequency range, number-of-points, and linear or log sweep.

Calibration: The software can use any calibration including a calibrated response gated in the time domain.

Fixture: The software works with simple transmission lines in coax or in rectangular waveguide containing a cross-sectional sample of the material-under-test.

Data display on CRT: Displays current measurement data, and can save/display 3 memory traces for comparison.

Data storage: Save/recall/export data via disk in MS-DOS ASCII format or HP BASIC BDAT format (HP LIF binary).

HP 85070A Dielectric Probe Kit

The HP 85070A Dielectric Probe Kit allows convenient non-destructive testing of materials using the open-ended coaxial probe method. The probe, together with its own dedicated software, determines the complex permittivity of a wide variety of liquids, semi-solids, and solids. Since the probe kit measures only permittivity, only non-magnetic materials should be measured. Measurements are efficient and cost-effective because the testing is non-destructive and there is no need for sample preparation or special fixtures.

Operating requirements

Standard: Requires MS-DOS on an HP Vectra (or any 100%-compatible PC-AT computer) compatible with Microsoft Windows 3.0 with mouse. Requires >20 Mbyte hard disk and >640 Kbytes RAM.

Option 300: Substitutes HP BASIC Software for the standard version for operation with HP 9000 series 300 controllers. Requires BASIC 5.0 or higher and 2 Mbytes of RAM.

Performance summary

Frequency range: 200 MHz to 20 GHz (typical, depending on network analyzer, fixture, and material).

Measurements (vs. frequency): ϵ_r' , ϵ_r'' , $\tan \delta$, or Cole-Cole diagram in linear format. Accuracy is 5% typical.

Stimulus control: Frequency range, number-of-points, and linear or log sweep.

Calibration: Guided, using open, short (included), and deionized water. Supports user-defined standards.

Data display on CRT: Displays current measurement data, and can save/display 3 memory traces for comparison.

Data storage: Save/recall/export data via disk in MS-DOS ASCII format or HP BASIC BDAT format (HP LIF binary).

HP 85014C Active Device Measurement Software

Description: With the HP 85014C software, an HP 8720 system can make complete automated S-parameter measurements of active devices in-fixture. The HP 85014C software provides the capability to use the TRL* calibration with in-fixture standards or the fixture can be de-embedded from the test device. With the HP 85041A Transistor Test Fixture, packaged transistors can be characterized from 45 MHz to 18 GHz in 0.070 and 0.100 inch stripline packages only. The software also provides automatic control of device biasing and hardcopy data outputs in a variety of formats.

Measurements (vs. frequency): S, H, Y, and Z parameters (Polar, Smith, Log or Linear Magnitude, Phase)

Amplifier summary: Lists or plots G_u, \max , G_A, \max , K, $[S_{21}]^2$, $[S_{12}]^2$, U, Mason's U, G1, and G2.

Termination summary: Lists or plot Γ_{MS} , Γ_{ML} , $1/S_{11}$, $1/S_{22}$.

Source control: Start, stop, number of points (51,101,201,401).

Power level, sweep mode, and averaging factor.

Calibration Kits: HP 85050B/D (7 mm)

Calibration types: Guided full 2-port in 7 mm with or without de-embedding. For non-7 mm interfaces, the software recalls any 2-port calibration (including in-fixture TRL* calibration) performed on the front panel.

Fixtures: HP 85041A Transistor Test Fixture (0.07 and 0.10 in. packages only). If a different fixture is then used, the fixture's S-parameters must be supplied as a "data file" for de-embedding.

Bias control: The software provides safe and oscillation-free automatic biasing of bipolar and field effect transistors with any of the following supplies: HP 6626A/29A Precision Power Supply
HP 4145A/B Semiconductor Parameter Analyzer
HP 4141B DC Source/Monitor
HP 4142B Modular DC Source/Monitor
Provision for manual control of the bias is also included.

Data storage: Binary, Touchstone, SuperCompact or CITIfile formats. S-parameter data may be stored to and retrieved from disc. Measurement configurations may also be stored.

Required equipment

HP 9000 Series 200 or 300 computer with the following:
BASIC Operating System (5.0 or higher)
RAM memory (including BASIC): 2 Mbytes
HP 9122C Dual Disc Drive (not required for HP 9836A/C)

Optional equipment

Test fixture:

HP 85041A Transistor Test Fixture, or other fixture

Bias Supply: HP 6626A, 6629A. (These supplies require HP 14852A Bias Cable to properly interface in the test set.) HP 8717B, 4145A, 4141B.

Bias Decoupling Network (Bipolar Transistors only):
HP 11635A

Plotter:

HP 7470A Opt. 002, 7475A Opt. 002, 7440A Opt. 002, 7090A Opt. 002, or 7550A.

Printer:

HP ThinkJet, QuietJet, DeskJet, and LaserJet series

Winchester hard disc drive:

HP 9153C, 7957B, 7958B, 7959B

Accessories

A wide range of accessories support the HP 8720 family of network analyzers, including calibration kits, verification kits, cables and adapters in both 7mm, 3.5mm, Type-N, and 2.4mm coax and in the standard waveguide bands. The standards used in the 3.5mm, Type-N, and 2.4mm calibration and verification kits use precision slotless connectors (PSC-3.5, PSC-N, and PSC-2.4).

Calibration kits

Before a network analyzer can make error-corrected measurements, the network analyzer's systematic errors must be measured and removed. Calibration is the process of quantifying these errors by measuring "known", or precision standards. The calibration kits listed below contain the precision standards required to calibrate the network analyzer. For calibrating a system in the 7mm, 3.5mm, Type-N, or 2.4mm interface, calibration kits all contain the following:

- Calibration standards to perform full-two port calibration
- Torque wrenches for properly connecting the standards
- Adapters to change the sex of the test port

Three classes of calibration kits are available:

Standard kits contain open circuits, short circuits, and both fixed and sliding terminations in both sexes for all connector types (except 7mm, a sexless connector). Connector gauges are included in these kits for maintaining each standards's connector interface.

Economy kits include the open circuit, short circuit, and fixed termination standards but not sliding terminations or gauges. Gauges can be ordered separately.

Waveguide calibration kits contain two coax-to-waveguide adapters with precision flanges, a flush short circuit, a precision waveguide line section, and either sliding or fixed terminations. They support calibrations based on TRL*, offset load, or short/offset-short/load/thru methods.

Calibration kits:

Cal Kit Type and Name	Frequency Range f_{min} - f_{max}	Connector Type	Return Loss, Fixed Load	Return Loss, Sliding Load (dB)	Return Loss, Airline (@ f_{max})	Residual Directivity ² @ f_{max}	Residual Source Match ² @ f_{max}
STANDARD							
HP 85050B	0.045-18 GHz	7 mm	≥52 dB, DC-2 GHz	≥ 52 dB, 2-18 GHz	—	45 dB	30 dB
HP 85052B	0.045-26.5 GHz	3.5 mm	≥44dB, DC-3 GHz	≥44 dB, 3-26.5 GHz	—	44 dB	30 dB
HP 85054B	0.045-18 GHz	Type N	≥48 dB, DC-2 GHz	≥42 dB, 2-18 GHz	—	42 dB	30 dB
HP 85056A	0.045-50 GHz	2.4 mm	≥42 dB, DC-4 GHz	≥36 dB @ 50 GHz	—	36 dB	31 dB
ECONOMY							
HP 85050D	0.045-18 GHz	7 mm	≥38 dB, DC-18 GHz	—	—	36 dB	30 dB
HP 85052D	0.045-26.5 GHz	3.5 mm	≥30 dB @ 26.5 GHz	—	—	36 dB	29 dB
HP 85054D	0.045-18 GHz	Type N	≥34 dB @ 18 GHz	—	—	34 dB	28 dB
HP 85056D	0.045-50 GHz	2.4 mm	≥26 dB @ 50 GHz	—	—	26 dB	23 dB
◇ HP 85056K	0.045-40 GHz	2.92 mm	≥26 dB @ 40 GHz	—	—	25 dB	22 dB
WAVEGUIDE							
◇ HP X11644A ¹	8.2-12.4 GHz	WR-90	≥42 dB, 8.2-12.4 GHz	—	50 dB	40 dB	30 dB
◇ HP P11644A ¹	12.4-18 GHz	WR-62	≥42 dB, 12.4-18 GHz	—	50 dB	40 dB	30 dB
◇ HP K11644A ¹	18-26.5 GHz	WR-42	≥42 dB, 18-26.5 GHz	—	50 dB	40 dB	30 dB
HP R11644A	26.5-40 GHz	WR-28	—	≥46 dB	50 dB	40 dB	30 dB

¹ Airline return loss, directivity and source match are typical values for these calibration kits.

² Residuals based on HP 8720C at f_{max} = 20 GHz for 3.5 mm kits or on HP 8722C at f_{max} = 40 GHz for 2.4 mm kits.

Verification kits

Verification kits are used to verify that a network analyzer is operating within its specified performance. Hewlett-Packard offers verification kits that include precision airlines, mismatch airlines, and precision fixed attenuators. All verification kits include measurement data and uncertainties which are traceable to the U.S. National Institute of Standards and Technology (NIST).

Verification kits

Verification Kit	Connector Type	Frequency Range (GHz)	Description (Contents)
HP 85051B	7 mm	0.045–18	10 cm airline, stepped impedance airline 20 dB, and 50 dB attenuators
HP 85053B	3.5 mm	0.045–26.5	7.5 cm airline, stepped impedance airline 20 dB, and 40 dB attenuators
HP 85055A	Type N	0.045–18	10 cm airline, stepped impedance airline, 20 dB and 50 dB attenuators
HP 85057B	2.4 mm	0.045–50	50Ω airline, stepped impedance airline, 20 dB and 40 dB attenuators

Note: HP 8722C compatible with HP 85053B and 85057B only.

Test port return cables

Test port cables are available in the 7mm, 3.5mm, Type N, and 2.4mm connectors types¹. The configurations and performance for all cables are described in the tables on the opposite page. All cables connect directly to the special ruggedized test port of the network analyzer test set (NMD connector).

Hewlett-Packard offers two cable designs: semi-rigid and flexible. Semi-rigid cables offer excellent performance and are suitable for applications where the connectors of the DUT are “in-line” or parallel. Flexible cables are ideal for manufacturing environments since they are more rugged and have a tighter bending radius than semi-rigid cables. Semi-rigid cables are warranted for 90 days; flexible cables are warranted for 1 year.

Either a single long cable or a shorter cable set can connect a coaxial device to the test set. A single cable with an appropriate test port adapter is best for applications where the DUT requires a connection next to the test port for mechanical rigidity. A set of cables offers the flexibility required to position the test devices away from the test set.

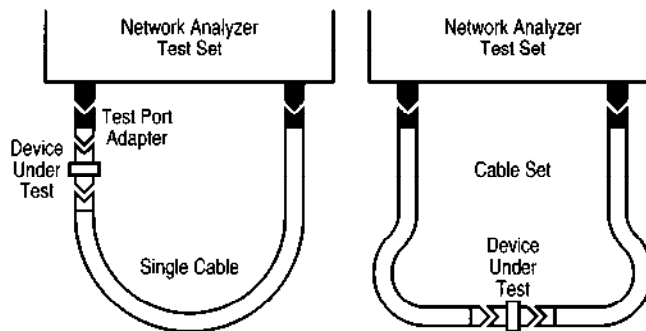

Test port adapter sets

The HP 85130 series test port adapter sets protect the test set port when connecting devices to the test port. These adapters, listed below with the single cables, convert the ruggedized test set port to a connection mateable with the device under test. Each set contains a male and a female adapter.

Adapter sets

Adapter Set	Connector Type (Test Port to Device)	Frequency (DC– f_{max})	Return Loss (dB) @ f_{max}
HP 85130C	NMD-3.5 mm to Type N	DC–18 GHz	≥28
HP 85130D	NMD-3.5 mm to PSC-3.5 mm (f) or NMD-3.5 mm (m)	DC–26.5 GHz	≥28
HP 85130E	NMD-2.4 mm to 7 mm	DC–18 GHz	≥26
HP 85130F	NMD-2.4 mm to PSC-3.5 mm (f) or NMD-3.5 mm (m)	DC–26.5 GHz	≥26
HP 85130G	NMD-2.4 mm to PSC-2.4 mm (f) or NMD-2.4 mm (m)	DC–50 GHz	≥23

HP 85043B Racked System Kit

HP 85043B Racked System Kit is a rack standing 128 cm (50.5 in) high, with a width of 60 cm (24 in), and a depth of 80 cm (32 in). Complete with support rails and AC power distribution (suitable for 50 to 60 Hz, 100 to 240 VAC, the kit includes rack mounting hardware for all instruments. Thermal design is such that no rack fan is needed.

¹ To measure Type N devices, use a pair of 7mm cables and the 7mm-to-Type N adapters provided in the HP 85054B,D calibration kits.

Test port return cable specifications

Single cables for HP HP 8719C and 8720C (3.5 mm)

	Connector Type (Test Port to Device)	Frequency (GHz)	Length ² cm (inch)	Return Loss(dB)	Insertion Loss (dB) (f in GHz)	Stability ^{1, 2} ±Magnitude (dB)	±Phase (degrees)
HP 85131C Semi-rigid Cable	NMD-3.5 mm to PSC-3.5 mm (f)	DC-26.5	81 (32)	≥17	0.43 √f +0.3 (2.5 dB @ f _{max})	<0.06	0.16 (f) +0.5
HP 85131E Flexible Cable	NMD-3.5 mm to PSC-3.5 mm (f)	DC-26.5	96.5 (38)	≥16	0.35 √f +0.3 (2.1 dB @ f _{max})	<0.22	0.16 (f) +0.8
HP 85132C Semi-rigid Cable	NMD-3.5 mm to 7 mm	DC-18	81 (32)	≥17	0.35 √f +0.3 (1.8 dB @ f _{max})	<0.06	0.16 (f) +0.5
HP 85132E Flexible Cable	NMD-3.5 mm to 7 mm	DC-18	97.2 (38.25)	≥17	0.35 √f +0.3 (1.8 dB @ f _{max})	<0.22	0.16 (f) +0.8

Cable set for HP 8719C and 8720C (3.5 mm)

	Connector Type (Test Port to Device)	Frequency (GHz)	Length ² cm (inch)	Return Loss(dB)	Insertion Loss (dB) (f in GHz)	Stability ^{1, 2} ±Magnitude (dB)	±Phase (degrees)
HP 85131D Semi-rigid Cable Set	NMD-3.5 mm to PSC-3.5 mm (f) or NMD-3.5 mm (m)	DC-26.5	53 (21)	≥16	0.30 √f +0.2 (1.8 dB @ f _{max})	<0.06	0.16 (f) +0.5
HP 85131F Flexible Cable Set	NMD-3.5 mm to PSC-3.5 mm (f) or NMD-3.5 mm (m)	DC-26.5	62.2 (24.5)	≥16	0.25 √f +0.2 (1.5 dB @ f _{max})	<0.12	0.13 (f) +0.5
HP 85132D Semi-rigid Cable Set	NMD-3.5 mm to 7 mm	DC-18	53 (21)	≥17	0.25 √f +0.2 (1.3 dB @ f _{max})	<0.06	0.16 (f) +0.5
HP 85132F Flexible Cable Set	NMD-3.5 mm to 7 mm	DC-18	62.9 (24.75)	≥17	0.25 √f +0.2 (1.3 dB @ f _{max})	<0.12	0.13 (f) +0.5

Single cables for HP 8722C (2.4 mm)

	Connector Type (Test Port to Device)	Frequency (GHz)	Length ² cm (inch)	Return Loss(dB)	Insertion Loss (dB) (f in GHz)	Stability ^{1, 2} ±Magnitude (dB)	±Phase (degrees)
HP 85133C Semi-rigid Cable	NMD-2.4 mm to PSC-2.4 mm (f)	DC-50	81 (32)	≥15	0.84 √f +0.3 (5.6 dB @ f _{max})	<0.06	0.18 (f)
HP 85133E Flexible Cable	NMD-2.4 mm to PSC-2.4 mm (f)	DC-50	113 (44)	≥12.5	0.58 √f +0.35 (4.45 dB @ f _{max})	<0.25	0.8 +0.16 (f)
HP 85134C Semi-rigid Cable	NMD-2.4 mm to PSC-3.5 mm (f)	DC-26.5	81 (32)	≥16	0.46 √f +0.3 (2.7 dB @ f _{max})	<0.06	0.18 (f)
HP 85134E Flexible Cable	NMD-2.4 mm to PSC-3.5 mm (f)	DC-26.5	97.2 (38.25)	≥16	0.46 √f +0.3 (2.7 dB @ f _{max})	<0.22	0.16 (f) +0.8
HP 85135C Semi-rigid Cable	NMD-2.4 mm to 7 mm	DC-18	81 (32)	≥17	0.46 √f +0.3 (2.25 dB @ f _{max})	<0.06	0.18 (f)
HP 85135E Flexible Cable	NMD-2.4 mm to 7 mm	DC-18	97.2 (38.25)	≥17	0.46 √f +0.3 (2.25 dB @ f _{max})	<0.22	0.16 (f) +0.8

Cable set for HP 8722C (2.4 mm)

	Connector Type (Test Port to Device)	Frequency (GHz)	Length ² cm (inch)	Return Loss(dB)	Insertion Loss (dB) (f in GHz)	Stability ^{1, 2} ±Magnitude (dB)	±Phase (degrees)
HP 85133D Semi-rigid Cable Set	NMD-2.4 mm to PSC-2.4 mm (f) or NMD-2.4 mm (m)	DC-50	53 (21)	≥15	0.55 √f +0.2 (3.7 dB @ f _{max})	<0.06	0.16 (f)
HP 85133F Flexible Cable Set	NMD-2.4 mm to PSC-2.4 mm (f) or NMD-2.4 mm (m)	DC-50	72 (28)	≥12.5	0.48 √f +0.25 (3.64 dB @ f _{max})	<0.17	0.8 + 0.16 (f)
HP 85134D Semi-rigid Cable Set	NMD-2.4 mm to PSC-3.5 mm (f) or NMD-3.5 mm (m)	DC-26.5	53 (21)	≥16	0.31 √f +0.2 (1.8 dB @ f _{max})	<0.06	0.18 (f)
HP 85134F Flexible Cable Set	NMD-2.4 mm to PSC-3.5 mm (f) or NMD-3.5 mm (m)	DC-26.5	62.9 (24.75)	≥16	0.31 √f +0.2 (1.8 dB @ f _{max})	<0.12	0.13 (f) +0.5
HP 85135D Semi-rigid Cable Set	NMD-2.4 mm to 7 mm	DC-18	53 (21)	≥17	0.31 √f +0.2 (1.5 dB @ f _{max})	<0.06	0.18 (f)
HP 85135F Flexible Cable Set	NMD-2.4 mm to 7 mm	DC-18	62.9 (24.75)	≥17	0.31 √f +0.2 (1.5 dB @ f _{max})	<0.12	0.13 (f) +0.5

¹ Phase stability of semi-rigid/flexible cables is specified with a 90 degree bend and a 47/3" radius.

² Cable length and stability are supplemental characteristics.

**For more information, call
your local HP sales office
listed in your telephone
directory.**

**For more information, call
your local HP sales office
listed in your telephone
directory or an HP regional
office listed below for the
location of your nearest sales
office.**

United States of America:

Rockville, MD
(301) 670 4300

Rolling Meadows, IL
(708) 255 9800

Fullerton, CA
(714) 999 6700

Atlanta, GA
(404) 980 7351

Canada:
(416) 678 9430

Japan:
(8113) 3335 8192

Latin America:
Mexico
(525) 202 0155

Brazil
(11) 709 1444

Australia/New Zealand:
(03) 895 2895

Far East:
Hong Kong
(852) 848 7070

Korea
(2) 769 0800

Taiwan
(2) 717 9524

Singapore
(65) 291 8554

India
(11) 690 355

PRC
(1) 505-3888

**In Europe, Africa, and Middle East
please call your local HP sales office
or representative:**

Austria/South East Area:
(0222) 2500-0

Belgium and Luxembourg:
(02) 761 31 11

Denmark:
45 99 10 00

Finland:
(90) 88 721

France:
(1) 69.82.65.00

Germany:
(06172) 16 0

Greece:
(01) 68 28 811

Ireland:
(01) 2844633

Israel:
(03) 5380 333

Italy:
(02) 95 300 930

Netherlands:
(020) 547 6669

Norway:
(02) 87 97 00

Portugal:
(11) 301 73 30

South Africa:
(011) 806 1000

Spain:
900 123 123

Sweden:
(08) 750 20 00

Switzerland:
(057) 31 21 11

Turkey:
(90-1) 4 125 83 13

U.K.:
(0344) 362 867

**For countries not listed,
contact Hewlett-Packard,
International Sales Branch,
Geneva, Switzerland
Tel: +41-22-780-7111
Fax: +41-22-780-7535**

**Data subject to Change
Copyright © 1992
Hewlett-Packard Company
Printed in U.S.A. 8/92
5091-5191 E**