

# Agilent 2-Port PNA-L Microwave Network Analyzer

## N5230A 10 MHz to 20, 40, 50 GHz

Data Sheet

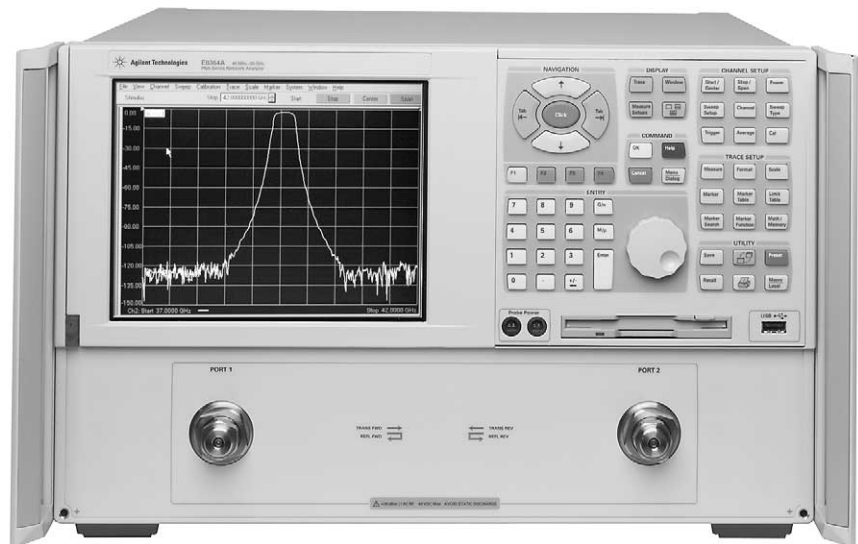

Note:

Specification information in this document is also available within the PNA-L network analyzer's internal Help system.



Agilent Technologies

# Table of Contents

<b>Definitions</b> .....	<b>3</b>
<b>Corrected System Performance</b> .....	<b>4</b>
Table 1. System dynamic range .....	4
Table 2. Extended dynamic range .....	5
N5230A Corrected system performance with 3.5mm connectors .....	6
Table 3. 85052B Calibration kit N5230A – Configurable test set and extended power range (Option 225) .....	6
Table 4. N4691A Electronic calibration module N5230A – Configurable test set and extended power range (Option 225) .....	8
Table 5. 85056A Calibration kit N5230A – Configurable test set and extended power range (Option 425 or 525) .....	10
Table 6. N4693A Electronic calibration module N5230A – Configurable test set and extended power range (Option 425 or 525) .....	12
Table 7. Uncorrected system performance .....	14
Table 8. Test port output .....	15
Table 9. Test port input .....	17
Table 10. Test port input (group delay) .....	24
<b>General Information</b> .....	<b>25</b>
Table 11. Miscellaneous information .....	25
Table 12. Front panel information .....	25
Table 13. Rear panel information .....	26
Table 14. Analyzer environment and dimensions .....	27
<b>Measurement Throughput Summary</b> .....	<b>28</b>
Table 15. Typical cycle time (ms) for measurement completion .....	28
Table 16. Cycle time vs IF bandwidth .....	28
Table 17. Cycle time vs number of points .....	29
Table 18. Data transfer time (ms) .....	29
<b>Specifications: Front-Panel Jumpers</b> .....	<b>30</b>
Table 19: Measurement receiver inputs (Rcvr A In, Rcvr B In) .....	30
Table 20: Reference receiver inputs (Rcvr R1, Rcvr R2) .....	31
Table 21: Reference outputs (Reference 1 Source out, Reference 2 Source Out) .....	31
Table 22: Source outputs (Port 1 source out, Port 2 Source Out) .....	31
Table 23: Coupler inputs (port 1 Cplr Thru, Port 2 Cplr Thru) .....	32
Table 24: Coupler outputs (port 1 Cplr Arm, Port 2 Cplr Arm) .....	32
<b>Test Set Block Diagrams</b> .....	<b>33</b>
N5230A Option 220, or 420, or 520 (standard test set and standard power range) network analyzer ...	33
N5230A Option 225, or 425, or 525 (configurable test set and extended power range) network analyzer .	33

---

This is a subset of technical specifications for the N5230A network analyzer.

To view or print the N5230A technical specifications, visit our web site at [www.agilent.com/find/pnal](http://www.agilent.com/find/pnal)

This N5230A document provides technical specifications for the following calibration kit and ECal module only: 85052B and N4691A. Please download our free Uncertainty Calculator from [www.agilent.com/find/na\\_calculator](http://www.agilent.com/find/na_calculator) to generate the curves for your calibration kit and PNA setup.

---

## Definitions

All specifications and characteristics apply over a 25 °C ±5 °C range (unless otherwise stated) and 90 minutes after the instrument has been turned on.

**Specification (spec.):** Warranted performance. Specifications include guardbands to account for the expected statistical performance distribution, measurement uncertainties, and changes in performance due to environmental conditions.

**Characteristic (char.):** A performance parameter that the product is expected to meet before it leaves the factory, but that is not verified in the field and is not covered by the product warranty. A characteristic includes the same guardbands as a specification.

**Typical (typ.):** Expected performance of an average unit which does not include guardbands. It is not covered by the product warranty.

**Nominal (nom.):** A general, descriptive term that does not imply a level of performance. It is not covered by the product warranty.

**Calibration:** The process of measuring known standards to characterize a network analyzer's systematic (repeatable) errors.

**Corrected (residual):** Indicates performance after error correction (calibration). It is determined by the quality of calibration standards and how well "known" they are, plus system repeatability, stability, and noise.

**Uncorrected (raw):** Indicates instrument performance without error correction. The uncorrected performance affects the stability of a calibration.

**Standard:** When referring to the analyzer, this includes no options unless noted otherwise.

## Corrected System Performance

The specifications in this section apply for measurements made with the N5230A analyzer with the following conditions:

- 10 Hz IF bandwidth
- No averaging applied to data
- Isolation calibration with an averaging factor of 8

**Table 1. System dynamic range<sup>1</sup>**

### Standard configuration and standard power range

Description	Specification (dB) at test port			Typical (dB) at test port		
	Option 220	Option 420	Option 520	Option 220	Option 420	Option 520
10 MHz to 45 MHz				103	89	89
45 MHz to 500 MHz <sup>2</sup>	105	90	90			
500 MHz to 2 GHz	110	110	110			
2 GHz to 8 GHz	110	110	110			
8 GHz to 10.5 GHz	110	100	100			
10.5 GHz to 12.5 GHz	110	100	100			
12.5 GHz to 20 GHz	108	100	100			
20 GHz to 31.25 GHz		95	95			
31.25 GHz to 40 GHz		90	90			
40 GHz to 50 GHz			79			

### Configurable test set and extended power range

Description	Specification (dB) at test port			Typical (dB) at test port		
	Option 225	Option 425	Option 525	Option 225	Option 425	Option 525
10 MHz to 45 MHz				103	88	88
45 MHz to 500 MHz <sup>2</sup>	105	90	90			
500 MHz to 2 GHz	110	110	110			
2 GHz to 8 GHz	110	110	110			
8 GHz to 10.5 GHz	110	100	100			
10.5 GHz to 12.5 GHz	110	100	100			
12.5 GHz to 20 GHz	108	100	100			
20 GHz to 31.25 GHz		92	92			
31.25 GHz to 40 GHz		87	87			
40 GHz to 50 GHz			75			

1. The system dynamic range is calculated as the difference between the noise floor and the specified source maximum output power. The effective dynamic range must take measurement uncertainties and interfering signals into account.
2. May be degraded by 10 dB at particular frequencies (multiples of 5 MHz) below 500 MHz due to spurious receiver residuals. Methods are available to regain the full dynamic range.

**Table 2. Extended dynamic range<sup>1</sup>**

**Configurable test set and extended power range**

Description	Specification (dB) at direct receiver access input			Typical (dB) at direct receiver access input		
	Option 225	Option 425	Option 525	Option 225	Option 425	Option 525
10 MHz to 45 MHz				115	109	109
45 MHz to 500 MHz <sup>2</sup>	117	111	111			
500 MHz to 2 GHz	122	122	122			
2 GHz to 8 GHz	122	122	122			
8 GHz to 10.5 GHz	122	112	112			
10.5 GHz to 12.5 GHz	122	112	112			
12.5 GHz to 20 GHz	120	112	112			
20 GHz to 31.25 GHz		103	103			
31.25 GHz to 40 GHz		98	98			
40 GHz to 50 GHz			83			

1. The direct receiver access input extended dynamic range is calculated as the difference between the direct receiver access input noise floor and the source maximum output power. The effective dynamic range must take measurement uncertainties and interfering signals into account. This set-up should only be used when the receiver input will never exceed its compression or damage level. When the analyzer is in segment sweep mode, it can have predefined frequency segments which will output a higher power level when the extended dynamic range is required (i.e. devices with high insertion loss), and reduced power when receiver compression or damage may occur (i.e. devices with low insertion loss). The extended range is only available in one-path transmission measurements.
2. May be degraded by 10 dB at particular frequencies (multiples of 5 MHz) below 500 MHz due to spurious receiver residuals. Methods are available to regain the full dynamic range.

## N5230A Corrected system performance with 3.5 mm connectors

Table 3. 85052B Calibration kit

N5230A – configurable test set and extended power range (Option 225)

### Configurable test set, extended power range

Applies to the, N5230A Option 225 analyzers, 85052B (3.5mm) calibration kit, 85131F flexible test port cable set, and a full 2-port calibration. Also applies to the following condition: Environmental temperature  $23^{\circ} \pm 3^{\circ} \text{C}$ , with  $< 1^{\circ} \text{C}$  deviation from calibration temperature.

Description	Specification (dB)			
	45 MHz to 500 MHz	500 MHz to 2 GHz	2 to 8 GHz	8 to 20 GHz
Directivity	48	48	44	44
Source match	40	40	33	31
Load match	48	48	44	44
Reflection tracking	$\pm 0.003$ (+0.02/°C)	$\pm 0.003$ (+0.02/°C)	$\pm 0.003$ (+0.03/°C)	$\pm 0.006$ (+0.03/°C)
Transmission tracking	$\pm 0.010$ (+0.02/°C)	$\pm 0.014$ (+0.02/°C)	$\pm 0.062$ (+0.03/°C)	$\pm 0.104$ (+0.03/°C)

### Transmission uncertainty (specifications)

Magnitude

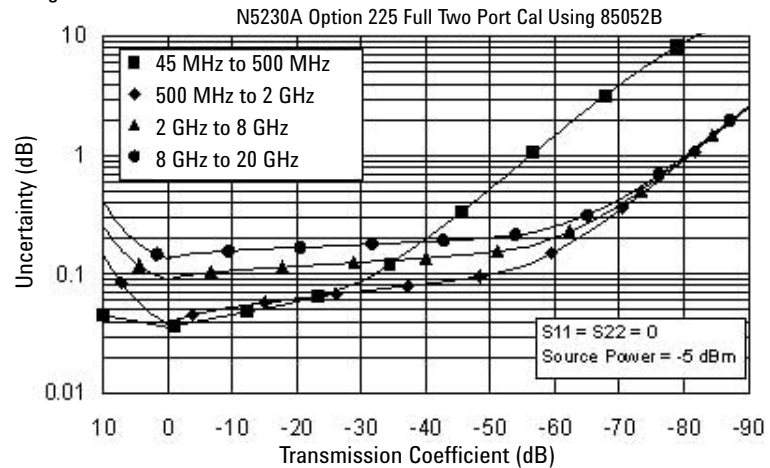

Phase

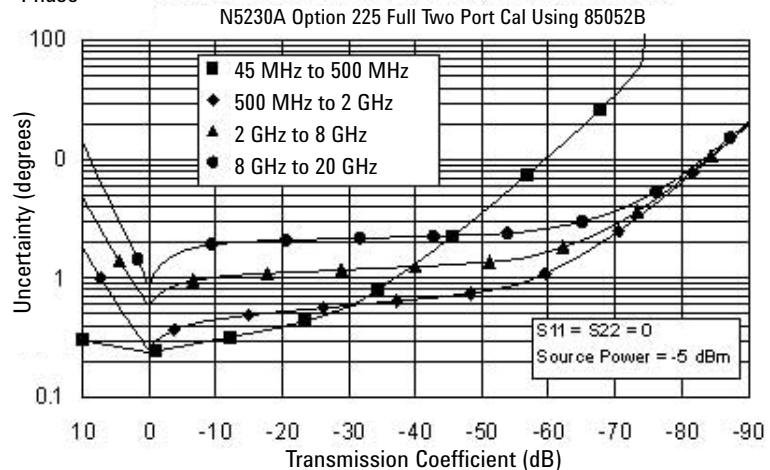

**N4691A Electronic calibration module**  
**N5230A – configurable test set and extended power range (Option 225)**

**Reflection uncertainty (specifications)**

Magnitude

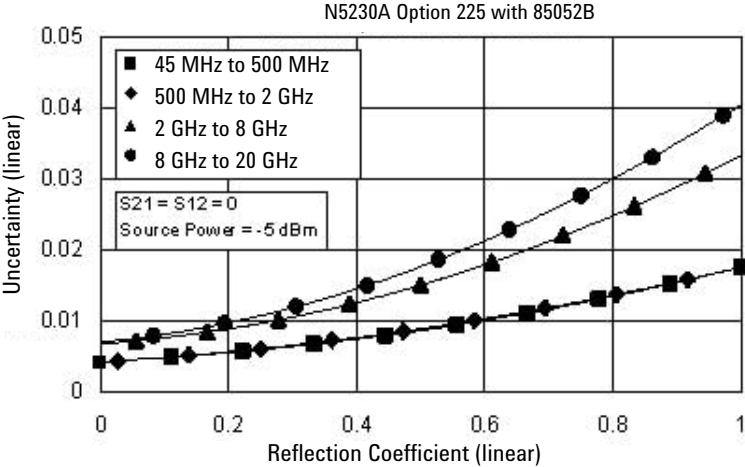

Phase

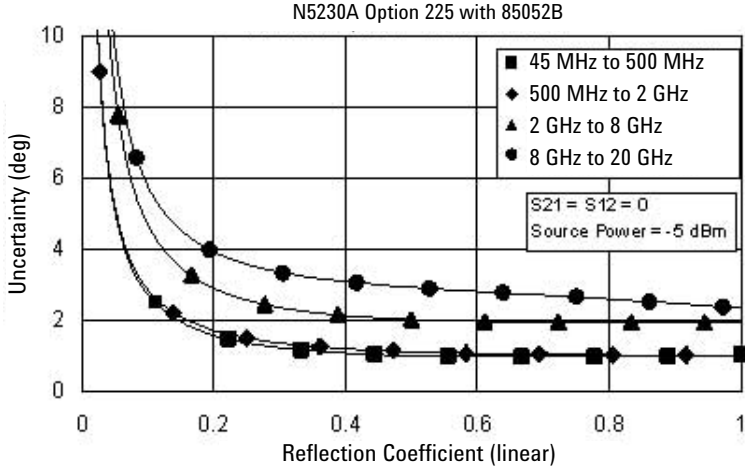

## N5230A Corrected system performance with 3.5 mm connectors

Table 4. N4691A Electronic calibration module  
N5230A – configurable test set and extended power range (Option 225)

### Configurable test set, extended power range

Applies to the, N5230A Option 225 analyzers, N4691A electronic calibration module, 85131F flexible test port cable set, and a full 2-port calibration. Also applies to the following condition: Environmental temperature  $23^{\circ} \pm 3^{\circ} \text{C}$ , with  $< 1^{\circ} \text{C}$  deviation from calibration temperature.

Description	Specification (dB)			
	45 MHz to 500 MHz	500 MHz to 2 GHz	2 to 8 GHz	8 to 20 GHz
Directivity	56	56	54	49
Source match	47	47	45	44
Load match	46	46	45	43
Reflection tracking	$\pm 0.050$ (+0.02/ $^{\circ}\text{C}$ )	$\pm 0.050$ (+0.02/ $^{\circ}\text{C}$ )	$\pm 0.070$ (+0.03/ $^{\circ}\text{C}$ )	$\pm 0.090$ (+0.03/ $^{\circ}\text{C}$ )
Transmission tracking	$\pm 0.054$ (+0.02/ $^{\circ}\text{C}$ )	$\pm 0.056$ (+0.02/ $^{\circ}\text{C}$ )	$\pm 0.057$ (+0.03/ $^{\circ}\text{C}$ )	$\pm 0.070$ (+0.03/ $^{\circ}\text{C}$ )

### Transmission uncertainty (specifications)

Magnitude

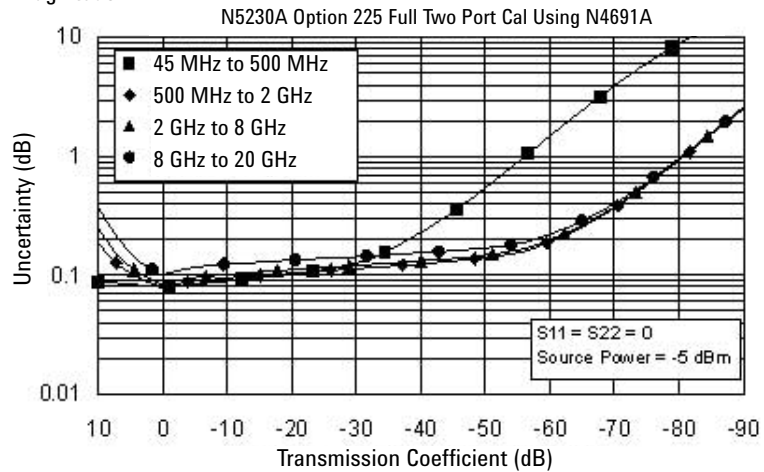

Phase

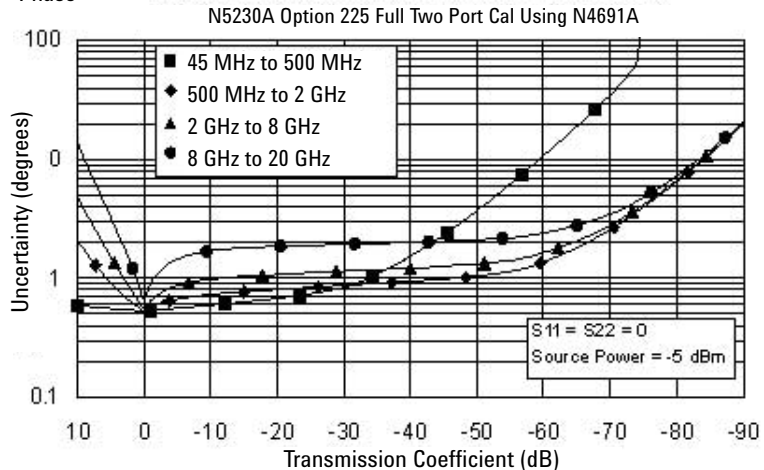



**N4691A Electronic calibration module**  
**N5230A – configurable test set and extended power range (Option 225)**

**Reflection uncertainty (specifications)**

Magnitude

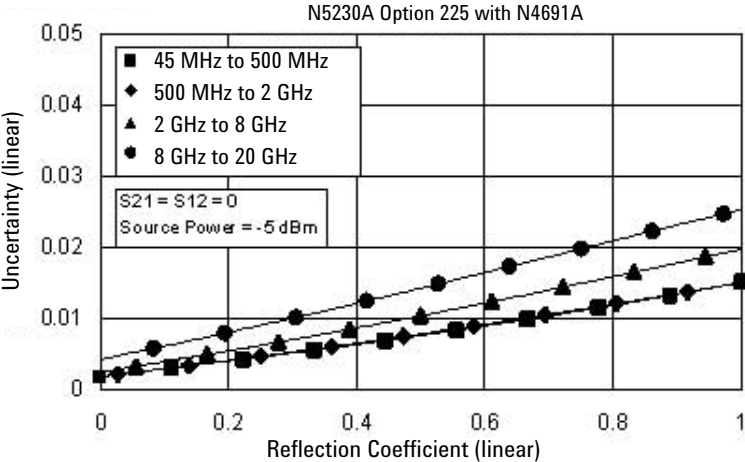

Phase

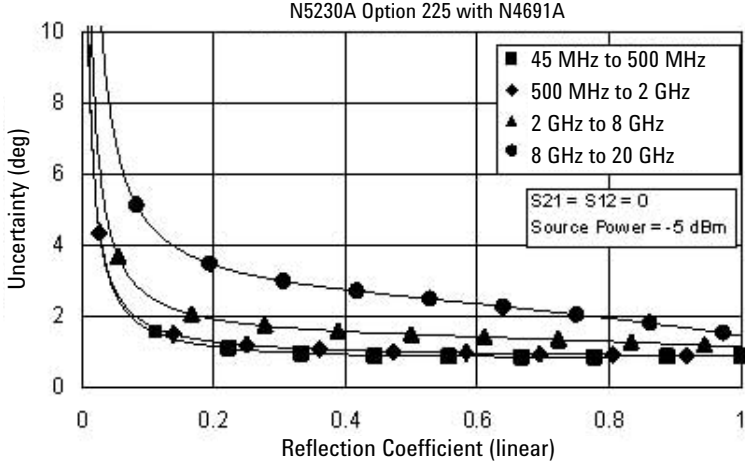

## N5230A Corrected system performance with 2.4 mm connectors

Table 5. 85056A Calibration kit  
N5230A – configurable test set and extended power range (Option 425 or 525)

### Configurable test set, extended power range

Applies to the N5230A Option 425 or 525 analyzers, 85056A (2.4 mm) electronic calibration module, 85133F flexible test port cable set, and a full 2-port calibration. Also applies to the following condition: Environmental temperature  $23^\circ \pm 3^\circ \text{C}$ , with  $< 1^\circ \text{C}$  deviation from calibration temperature.

Description	Specification (dB)			
	45 MHz to 2 GHz	2 to 20 GHz	20 to 40 GHz	40 to 50 GHz
Directivity	42	42	38	36
Source match	41	38	33	31
Load match	42	42	37	35
Reflection tracking	$\pm 0.001$ (+0.02/ $^\circ\text{C}$ )	$\pm 0.008$ (+0.02/ $^\circ\text{C}$ )	$\pm 0.020$ (+0.02/ $^\circ\text{C}$ )	$\pm 0.027$ (+0.03/ $^\circ\text{C}$ )
Transmission tracking	$\pm 0.019$ (+0.02/ $^\circ\text{C}$ )	$\pm 0.057$ (+0.02/ $^\circ\text{C}$ )	$\pm 0.124$ (+0.02/ $^\circ\text{C}$ )	$\pm 0.211$ (+0.03/ $^\circ\text{C}$ )

### Transmission uncertainty (specifications)

#### Magnitude

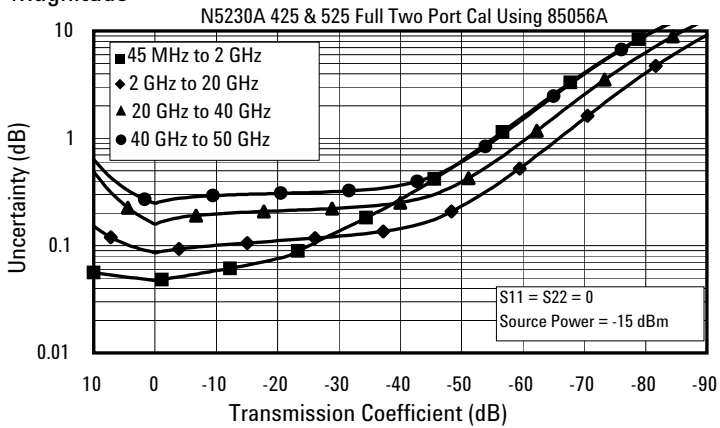

#### Phase

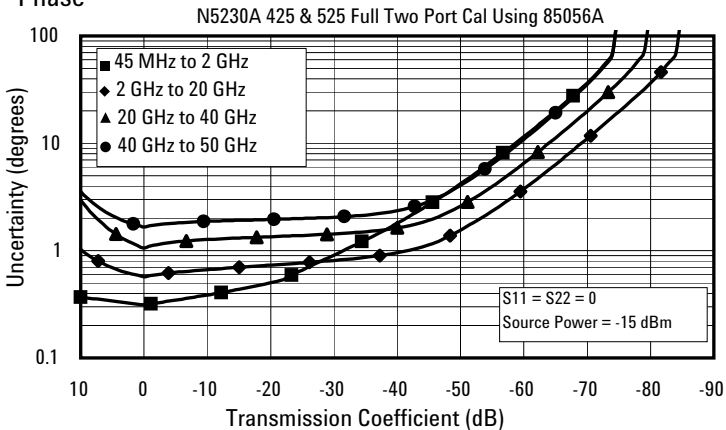

**Reflection uncertainty (specifications)**

**Magnitude**

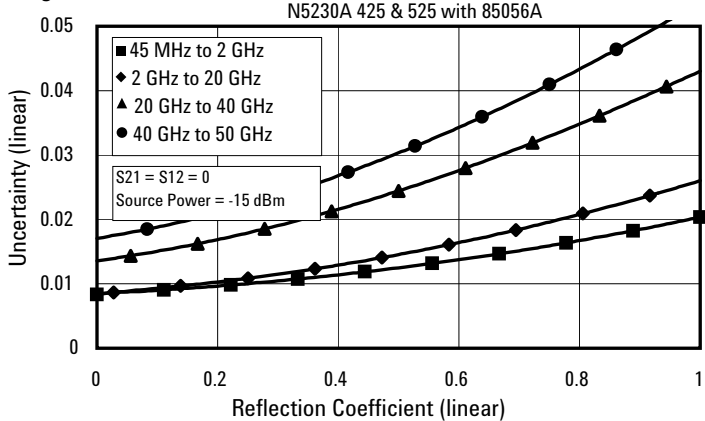

**Phase**

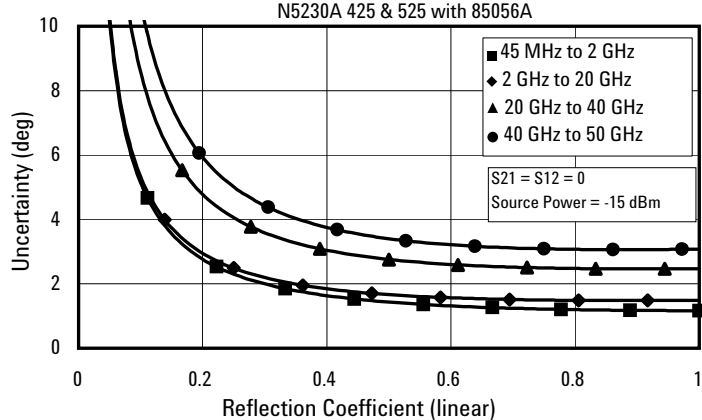

**Table 6. N4693A Electronic calibration module  
N5230A – configurable test set and extended power range (Option 425 or 525)**

**Configurable test set, extended power range**

Applies to the N5230A Option 425 or 525 analyzers, N4693A (2.4 mm) electronic calibration module, 85133F flexible test port cable set, and a full 2-port calibration. Also applies to the following condition: Environmental temperature  $23^{\circ} \pm 3^{\circ} \text{C}$ , with  $< 1^{\circ} \text{C}$  deviation from calibration temperature

Description	Specification (dB)			
	45 MHz to 2 GHz	2 to 20 GHz	20 to 40 GHz	40 to 50 GHz
Directivity	55	49	43	41
Source match	46	42	35	30
Load match	43	41	37	36
Reflection tracking	$\pm 0.030$ ( $+0.02/^{\circ}\text{C}$ )	$\pm 0.040$ ( $+0.02/^{\circ}\text{C}$ )	$\pm 0.060$ ( $+0.02/^{\circ}\text{C}$ )	$\pm 0.080$ ( $+0.03/^{\circ}\text{C}$ )
Transmission tracking	$\pm 0.056$ ( $+0.02/^{\circ}\text{C}$ )	$\pm 0.078$ ( $+0.02/^{\circ}\text{C}$ )	$\pm 0.107$ ( $+0.02/^{\circ}\text{C}$ )	$\pm 0.130$ ( $+0.03/^{\circ}\text{C}$ )

**Transmission uncertainty (specifications)**

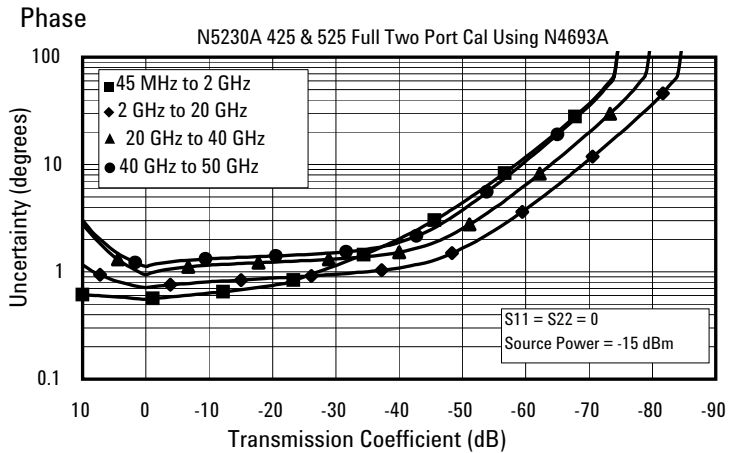
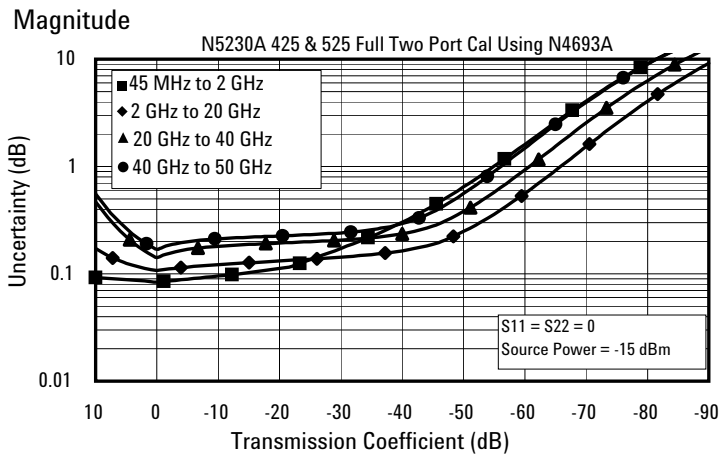

**Reflection uncertainty (specifications)**

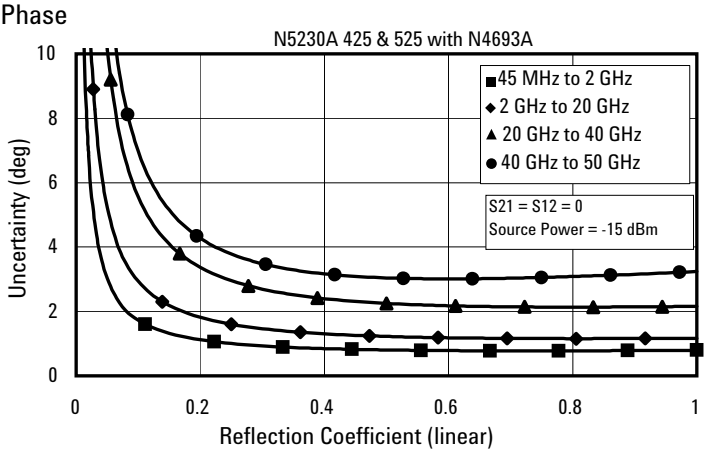
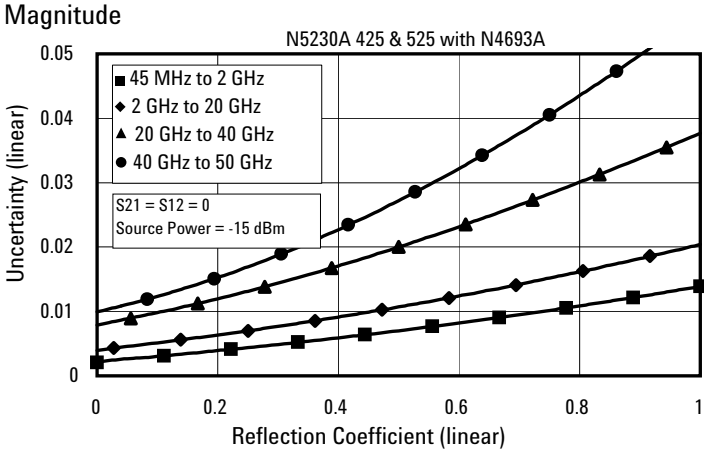

This N5230A document does not present specifications for the 85056D or 85056K Calibration Kit. Please download our free Uncertainty Calculator from [www.agilent.com/find/na\\_calculator](http://www.agilent.com/find/na_calculator) to generate the data and curves for the 85056D and 85056K Calibration Kit or your PNA setup.

**Table 7. Uncorrected system performance**

Directivity	Specifications			Typicals		
	Option 220, 225	Option 420, 425	Option 520, 525	Option 220, 225	Option 420, 425	Option 520, 525
10 MHz to 45 MHz				24 dB	20 dB	20 dB
45 MHz to 500 MHz	24 dB	23 dB	23 dB			
500 MHz to 2 GHz	27 dB	23 dB	23 dB			
2 GHz to 8 GHz	21 dB	21 dB	21 dB			
8 GHz to 12.5 GHz	16 dB	16 dB	16 dB			
12.5 GHz to 20 GHz	16 dB	16 dB	16 dB			
20 GHz to 40 GHz		15 dB	15 dB			
40 GHz to 45 GHz			15 dB			
45 GHz to 50 GHz			13 dB			
<b>Source match</b>	<b>Option 220, 225</b>	<b>Option 420, 520</b>	<b>Option 425, 525</b>	<b>Option 220, 225</b>	<b>Option 420, 520</b>	<b>Option 425, 525</b>
10 MHz to 45 MHz				12 dB	11 dB	11 dB
45 MHz to 500 MHz	20 dB	17 dB	17 dB			
500 MHz to 2 GHz	17 dB	17 dB	17 dB			
2 GHz to 8 GHz	12 dB	12 dB	12 dB			
8 GHz to 12.5 GHz	11 dB	11 dB	11 dB			
12.5 GHz to 20 GHz	10 dB	11 dB	11 dB			
20 GHz to 40 GHz		7 dB	7 dB			
40 GHz to 50 GHz			6 dB			
<b>Load match</b>	<b>Option 220, 225</b>	<b>Option 420, 520</b>	<b>Option 425, 525</b>	<b>Option 220, 225</b>	<b>Option 420, 520</b>	<b>Option 425, 525</b>
10 MHz to 45 MHz				15 dB	13 dB	13 dB
45 MHz to 500 MHz	22 dB	18 dB	18 dB			
500 MHz to 2 GHz	20 dB	18 dB	18 dB			
2 GHz to 8 GHz	12 dB	14 dB	14 dB			
8 GHz to 12.5 GHz	10 dB	12 dB	12 dB			
12.5 GHz to 20 GHz	9 dB	9.5 dB	9.5 dB			
20 GHz to 40 GHz		8.5 dB	8.5 dB			
40 GHz to 50 GHz		5 dB	5 dB			
<b>Crosstalk<sup>1</sup></b>	<b>Option 220, 225</b>	<b>Option 420, 425</b>	<b>Option 520, 525</b>	<b>Option 220, 225</b>	<b>Option 420, 425</b>	<b>Option 520, 525</b>
10 MHz to 45 MHz				88 dB	88 dB	88 dB
45 MHz to 500 MHz				95 dB	94 dB	94 dB
500 MHz to 2 GHz				96 dB	95 dB	95 dB
2 GHz to 8 GHz				110 dB	108 dB	108 dB
8 GHz to 12.5 GHz				116 dB	113 dB	113 dB
12.5 GHz to 20 GHz				115 dB	112 dB	112 dB
20 GHz to 40 GHz					97 dB	97 dB
40 GHz to 50 GHz						89 dB

1. Measurement conditions: normalized to a thru, measured with two shorts, 10 Hz IF bandwidth, averaging factor of 8, alternate mode, source power set to the lesser of the specified maximum power output or the maximum receiver input power specified by the 0.1 dB compression power.

Table 8. Test port output<sup>1</sup>

Description	Specifications			Typicals		
	Option 220, 225	Option 420, 425	Option 520, 525	Option 220, 225	Option 420, 425	Option 520, 525
<b>Frequency range</b> N5230A	10 MHz to 20 GHz	10 MHz to 40 GHz	10 MHz to 50 GHz			
<b>Nominal power</b>	Preset power; attenuator switch point 10 dB below nominal power					
	-5 dBm	-10 dBm	-15 dBm			
<b>Frequency resolution</b>	1 Hz					
<b>CW accuracy</b>	±1 ppm					
<b>Frequency stability</b>				±0.05 ppm. -10° to 70° C ±0.1 ppm/yr maximum		

Description	Specifications			Typicals	
	Option 220, 225	Option 420, 425	Option 520, 525	Option 220, 225	Option 420, 425 520, 525
<b>Power level accuracy</b>	Variation from nominal power in range 0				
10 MHz to 45 MHz				±0.5 dB	±0.5 dB
45 MHz to 8 GHz	±1.0 dB	±1.0 dB	±1.0 dB		
8 GHz to 12.5 GHz	±1.0 dB	±1.5 dB	±1.5 dB		
12.5 GHz to 20 GHz	±1.0 dB	±1.5 dB	±1.5 dB		
20 GHz to 40 GHz		±2.5 dB	±2.5 dB		
40 GHz to 50 GHz			±3.5 dB		

Description	Specifications					Typicals Options as indicated
	Option 220, 225	Option 420	Option 425	Option 520	Option 525	
<b>Max leveled power</b>						
45 MHz to 12.5 GHz	5 dBm	0 dBm	0 dBm	0 dBm	0 dBm	
12.5 GHz to 20 GHz	3 dBm	0 dBm	0 dBm	0 dBm	0 dBm	
20 GHz to 40 GHz		-5 dBm	-8 dBm	-5 dBm	-8 dBm	
40 GHz to 50 GHz				-11 dBm	-15 dBm	
<b>Power level linearity<sup>2</sup></b>	Test reference is at the nominal power level					
10 MHz to 45 MHz						±0.35 dB (Opt 220 & 225) ±0.40 dB (Opt 420, 425, 520, 525)
45 MHz to 12.5 GHz	±1.0 dB	±1.0 dB	±1.0 dB	±1.0 dB	±1.0 dB	
12.5 GHz to 20 GHz	±1.0 dB	±1.0 dB	±1.0 dB	±1.0 dB	±1.0 dB	
20 GHz to 40 GHz		±1.0 dB	±1.0 dB	±1.0 dB	±1.0 dB	
40 GHz to 50 GHz				±1.0 dB	±1.0 dB	
<b>Power sweep range (ALC)<sup>3</sup></b>						
45 MHz to 12.5 GHz	25 dB	25 dB	25 dB	25 dB	25 dB	
12.5 GHz to 20 GHz	23 dB	25 dB	25 dB	25 dB	25 dB	
20 GHz to 40 GHz		20 dB	17 dB	20 dB	17 dB	
40 GHz to 50 GHz				14 dB	10 dB	
<b>Power resolution</b>	0.01 dB					

1. Performance specified on Port 1 only. Port 2 performance is a characteristic.

2. Power level linearity specified on Port 1 only. Port 2 performance is Typical.  
Test reference is at the nominal power level.

3. ALC range starts at maximum leveled power and goes down the power level indicated by the dB amount specified here.

**Table 8. Test port output<sup>1</sup>** (Continued)

Description	Specifications	Typicals			
		Option 220	Option 225	Option 420, 520	Option 425, 525
<b>Power range</b>					
10 MHz to 45 MHz		-27 to +14 dBm	-87 to +12 dBm	-27 to +9 dBm	-87 to +8 dBm
45 MHz to 12.5 GHz		-27 to +14 dBm	-87 to +12 dBm	-27 to +8 dBm	-87 to +8 dBm
12.5 GHz to 20 GHz		-27 to +10 dBm	-87 to +7 dBm	-27 to +5 dBm	-87 to +4 dBm
20 GHz to 40 GHz				-27 to +1 dBm	-87 to -2 dBm
40 GHz to 50 GHz				-27 to -5 dBm	-87 to -9 dBm
<b>Power settings</b>					
Minimum power setting		-30 dBm	-90 dBm	-30 dBm	-90 dBm
Maximum power setting				+20 dBm	

Description	Specifications	Typicals		
		Options 220, 225, 420, 425, 520, 525		
<b>Phase noise (Nominal power at test port)</b>				
		<b>10 kHz Offset</b>	<b>100 kHz Offset</b>	<b>1 MHz Offset</b>
10 MHz to 1.5 GHz		-77 dBc/Hz	-77 dBc/Hz	-89 dBc/Hz
1.5 GHz to 3.125 GHz		-83 dBc/Hz	-91 dBc/Hz	-95 dBc/Hz
3.125 GHz to 6.25 GHz		-77 dBc/Hz	-85 dBc/Hz	-89 dBc/Hz
6.25 GHz to 12.5 GHz		-71 dBc/Hz	-79 dBc/Hz	-83 dBc/Hz
12.5 GHz to 20 GHz		-65 dBc/Hz	-73 dBc/Hz	-77 dBc/Hz
20 GHz to 40 GHz		-59 dBc/Hz	-67 dBc/Hz	-71 dBc/Hz
40 GHz to 50 GHz		-59 dBc/Hz	-67 dBc/Hz	-71 dBc/Hz
<b>Non-harmonic spurious (at nominal output power)</b>				
10 MHz to 20 GHz		-50 dBc for offset frequency > 1 kHz		
20 GHz to 40 GHz		-30 dBc for offset frequency > 1 kHz		
40 GHz to 50 GHz		-30 dBc for offset frequency > 1 kHz		

Description	Specifications	Typicals		
		Option 220, 225	Option 420, 425	Option 520, 525
<b>Harmonics (2nd or 3rd) at maximum output power</b>				
10 MHz to 500 MHz		-22 dBc	-15 dBc	-15 dBc
500 MHz to 20 GHz		-22 dBc	-20 dBc	-20 dBc
20 GHz to 40 GHz			-22 dBc	-22 dBc
40 GHz to 50 GHz				-22 dBc

1. Performance specified on Port 1 only. Port 2 performance is a characteristic.
2. Power level linearity specified on Port 1 only. Port 2 performance is Typical. Test reference is at the nominal power level.
3. ALC range starts at maximum leveled power and goes down the power level indicated by the dB amount specified here.



Table 9: Test port input

Description	Specification			Typicals		
	Option 220, 225	Option 420, 425	Option 520, 525	Option 220, 225	Option 420, 425	Option 520, 525
<b>Test port noise floor<sup>1</sup></b>						
<b>10 Hz IF bandwidth</b>						
10 MHz to 45 MHz				< -89 dBm	< -80 dBm	< -80 dBm
45 MHz to 500 MHz	< -100 dBm	< -90 dBm	< -90 dBm			
500 MHz to 2 GHz	< -105 dBm	< -110 dBm	< -110 dBm			
2 GHz to 8 GHz	< -105 dBm	< -110 dBm	< -110 dBm			
8 GHz to 10.5 GHz	< -105 dBm	< -100 dBm	< -100 dBm			
10.5 GHz to 20 GHz	< -105 dBm	< -100 dBm	< -100 dBm			
20 GHz to 31.25 GHz		< -100 dBm	< -100 dBm			
31.25 GHz to 40 GHz		< -95 dBm	< -95 dBm			
40 GHz to 50 GHz			< -90 dBm			
<b>Test port noise floor<sup>1</sup></b>						
<b>1 KHz IF bandwidth</b>						
10 MHz to 45 MHz				< -69 dBm	< -60 dBm	< -60 dBm
45 MHz to 500 MHz	< -80 dBm	< -70 dBm	< -70 dBm			
500 MHz to 2 GHz	< -85 dBm	< -90 dBm	< -90 dBm			
2 GHz to 8 GHz	< -85 dBm	< -90 dBm	< -90 dBm			
8 GHz to 10.5 GHz	< -85 dBm	< -80 dBm	< -80 dBm			
10.5 GHz to 20 GHz	< -85 dBm	< -80 dBm	< -80 dBm			
20 GHz to 31.25 GHz		< -80 dBm	< -80 dBm			
31.25 GHz to 40 GHz		< -75 dBm	< -75 dBm			
40 GHz to 50 GHz			< -70 dBm			
<b>Direct receiver access input noise floor<sup>1</sup></b>						
<b>10 Hz IF bandwidth</b>						
10 MHz to 45 MHz				< -120 dBm	< -126 dBm	< -126 dBm
45 MHz to 500 MHz	< -112 dBm	< -111 dBm	< -111 dBm			
500 MHz to 2 GHz	< -117 dBm	< -122 dBm	< -122 dBm			
2 GHz to 8 GHz	< -117 dBm	< -122 dBm	< -122 dBm			
8 GHz to 10.5 GHz	< -117 dBm	< -112 dBm	< -112 dBm			
10.5 GHz to 20 GHz	< -117 dBm	< -112 dBm	< -112 dBm			
20 GHz to 31.25 GHz		< -111 dBm	< -111 dBm			
31.25 GHz to 40 GHz		< -106 dBm	< -106 dBm			
40 GHz to 50 GHz			< -98 dBm			
<b>Direct receiver access input noise floor<sup>1</sup></b>						
<b>1 KHz IF bandwidth</b>						
10 MHz to 45 MHz				< -100 dBm	< -106 dBm	< -106 dBm
45 MHz to 500 MHz	< -92 dBm	< -91 dBm	< -91 dBm			
500 MHz to 2 GHz	< -97 dBm	< -102 dBm	< -102 dBm			
2 GHz to 8 GHz	< -97 dBm	< -102 dBm	< -102 dBm			
8 GHz to 10.5 GHz	< -97 dBm	< -92 dBm	< -92 dBm			
10.5 GHz to 20 GHz	< -97 dBm	< -92 dBm	< -92 dBm			
20 GHz to 31.25 GHz		< -91 dBm	< -91 dBm			
3.125 GHz to 40 GHz		< -86 dBm	< -86 dBm			
40 GHz to 50 GHz			< -78 dBm			

Table 9: Test port input (Continued)

Description	Specifications						Typicals
	Option 220, 225		Option 420, 520		Option 425, 525		
<b>Compression level</b>							
	Power	Compression	Power	Compression	Power	Compression	
10 MHz to 45 MHz <sup>2</sup>							
45 MHz to 500 MHz	+5 dBm	0.10 dB	+5 dBm	0.40 dB	+5 dBm	0.40 dB	
500 MHz to 2 GHz	+5 dBm	0.15 dB	+5 dBm	0.77 dB	+5 dBm	0.67 dB	
2 GHz to 8 GHz	+5 dBm	0.21 dB	+5 dBm	0.75 dB	+5 dBm	0.55 dB	
8 GHz to 12.5 GHz	+5 dBm	0.21 dB	+5 dBm	0.56 dB	+5 dBm	0.51 dB	
12.5 GHz to 20 GHz	+3 dBm	0.20 dB	+5 dBm	0.79 dB	+5 dBm	0.69 dB	
20 GHz to 31.25 GHz			0 dBm	0.60 dB	0 dBm	0.50 dB	
31.25 GHz to 40 GHz			-3 dBm	0.55 dB	-3 dBm	0.60 dB	
40 GHz to 50 GHz			-3 dBm	0.66 dB	-3 dBm	0.71 dB	

Description	Specifications			Typicals		
	Option 220, 225	Option 420, 520	Option 425, 525	Option 220, 225	Option 420, 520	Option 425, 525
<b>Test port compression - 0.1 dB</b>						
10 MHz to 45 MHz <sup>2</sup>				negligible	negligible	negligible
45 MHz to 500 MHz				+10 dBm	0.0 dBm	+1.0 dBm
500 MHz to 2 GHz				+9 dBm	0.0 dBm	+1.0 dBm
2 GHz to 12.5 GHz				+6 dBm	0.0 dBm	+1.5 dBm
12.5 GHz to 20 GHz				+6 dBm	-1.0 dBm	0.0 dBm
20 GHz to 31.25 GHz					-5.5 dBm	-3.0 dBm
31.25 GHz to 40 GHz					-8.5 dBm	-7.5 dBm
40 GHz to 50 GHz					-11.5 dBm	-10.0 dBm

**Trace noise magnitude<sup>3</sup>**

1 kHz IF bandwidth, ratioed measurement, nominal power at test port.

10 MHz to 45 MHz				0.004 dB rms	0.015 dB rms	0.015 dB rms
45 MHz to 500 MHz	0.004 dB rms	0.010 dB rms	0.010 dB rms			
500 MHz to 2 GHz	0.004 dB rms	0.006 dB rms	0.006 dB rms			
2 GHz to 10.5 GHz	0.004 dB rms	0.006 dB rms	0.006 dB rms			
10.5 GHz to 20 GHz	0.006 dB rms	0.010 dB rms	0.010 dB rms			
20 GHz to 31.25 GHz		0.010 dB rms	0.010 dB rms			
31.25 GHz to 40 GHz		0.020 dB rms	0.020 dB rms			
40 GHz to 50 GHz			0.020 dB rms			

## Dynamic accuracy, 12.5 – 20 GHz

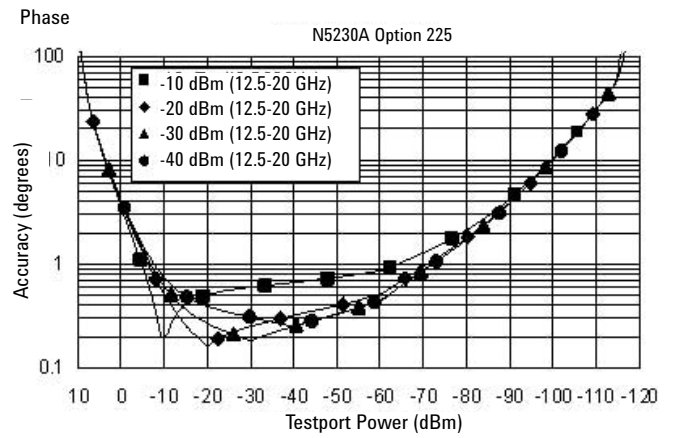
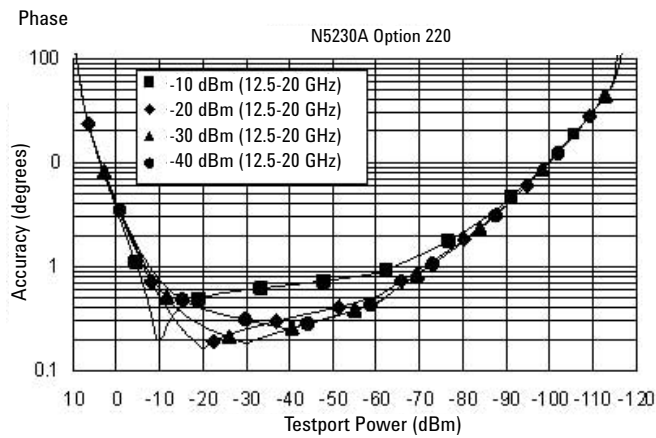
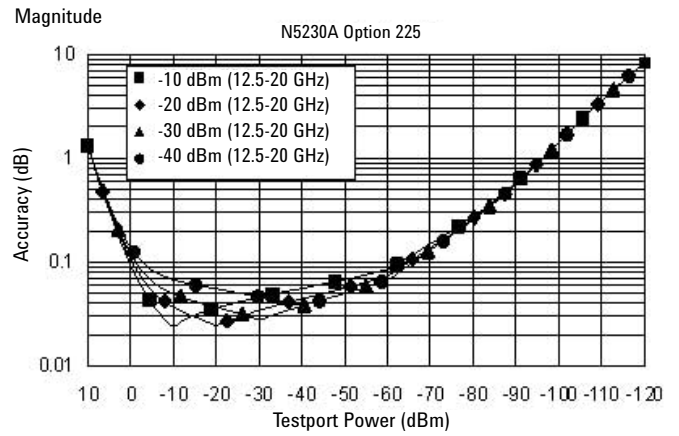
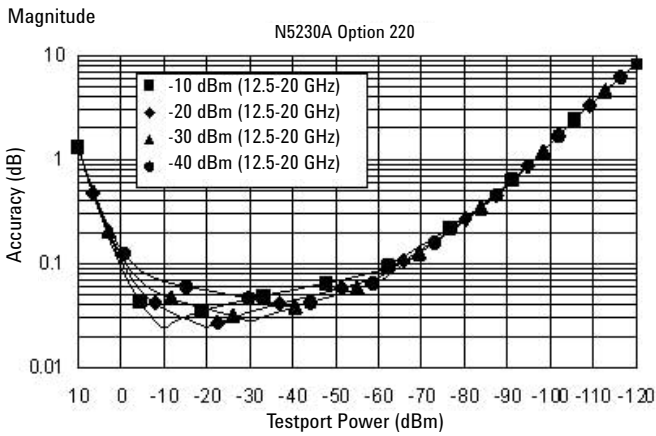

# Dynamic accuracy, 12.5 – 20 GHz

## Magnitude

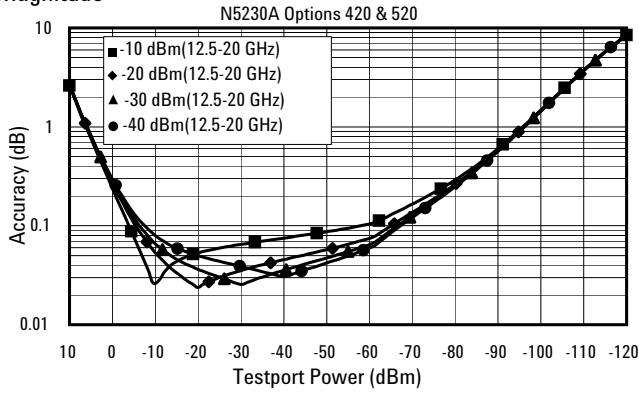

## Magnitude

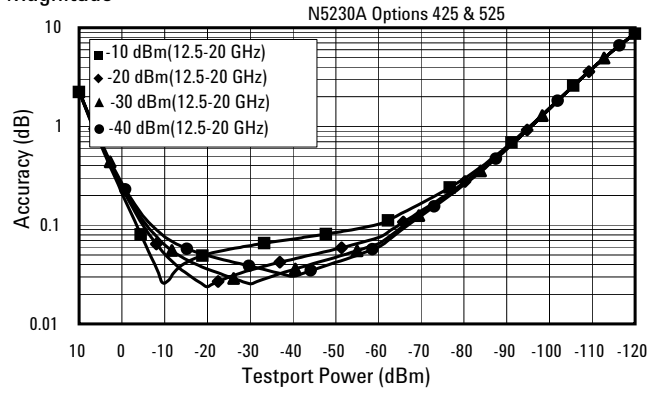

## Phase

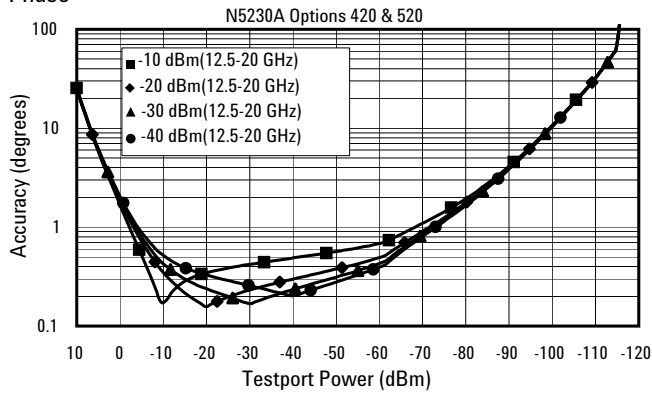

## Phase

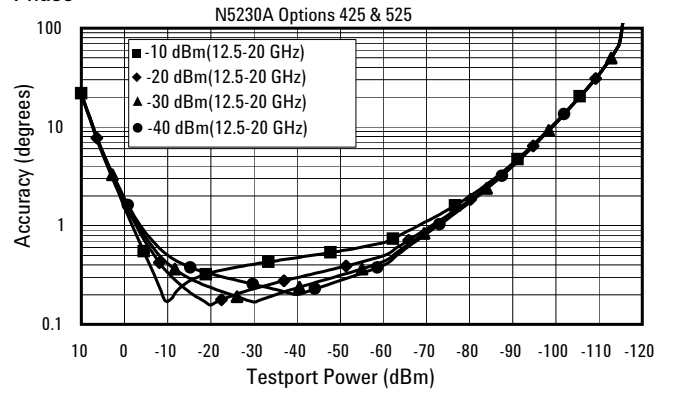

## Dynamic accuracy, 20 – 31.25 GHz

Magnitude

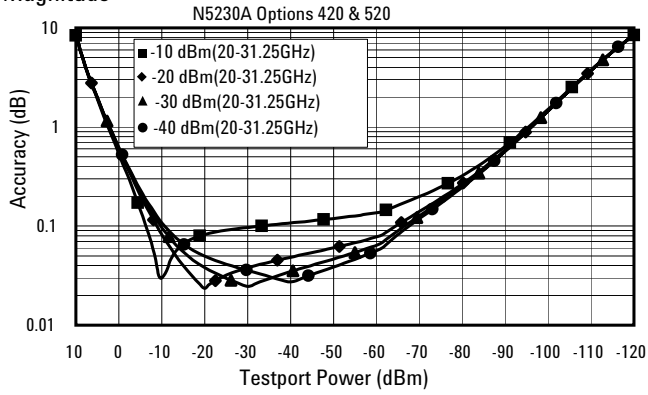

Magnitude

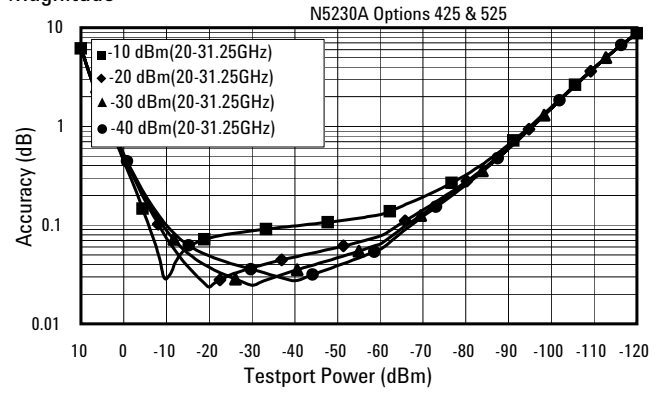

Phase

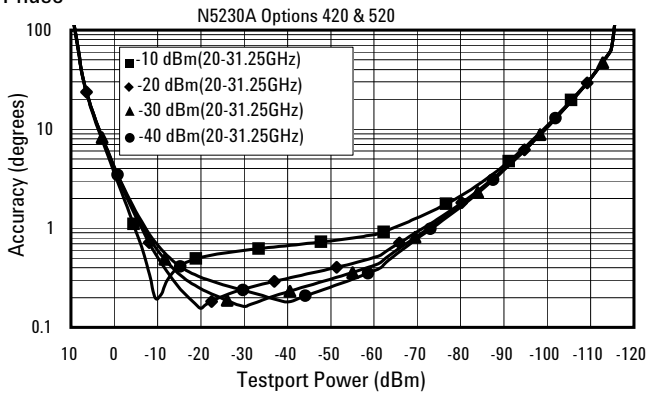

Phase

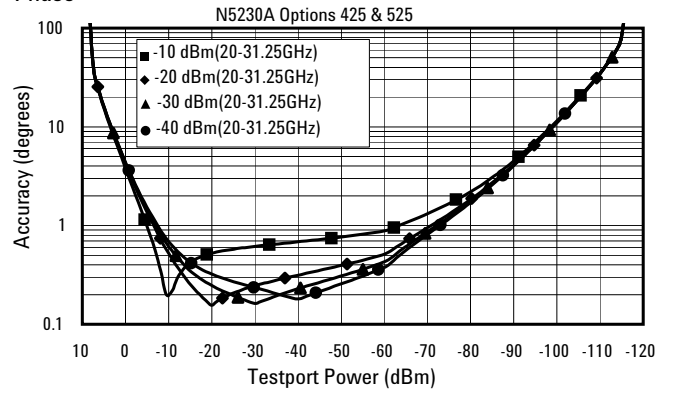

### Dynamic accuracy, 31.25 – 40 GHz

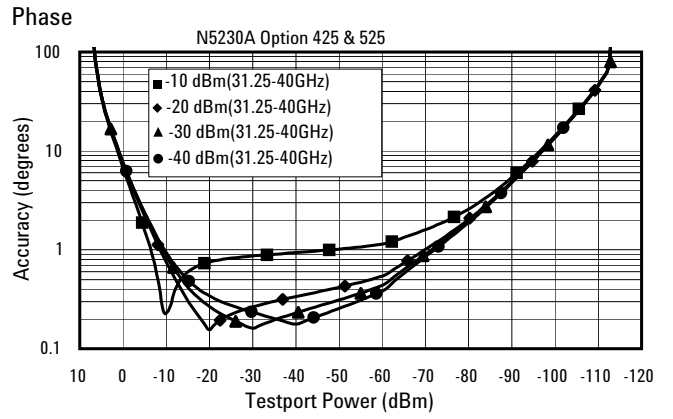
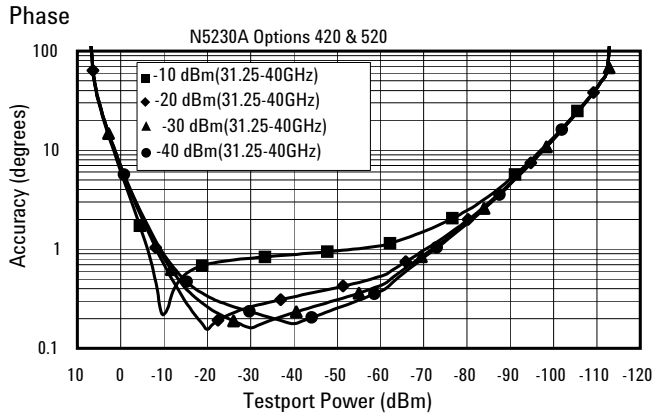
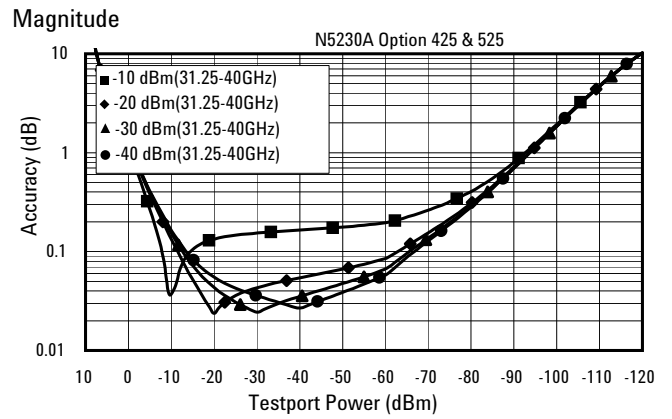
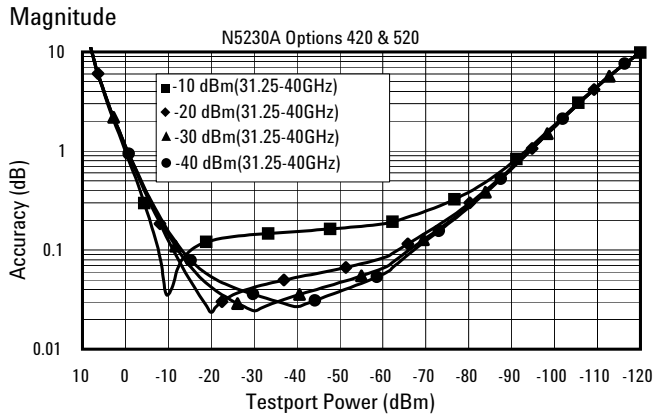

## Dynamic accuracy, 40 – 50 GHz

Magnitude

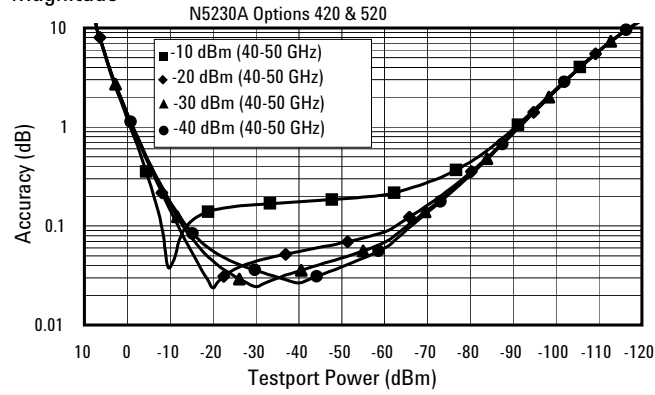

Magnitude

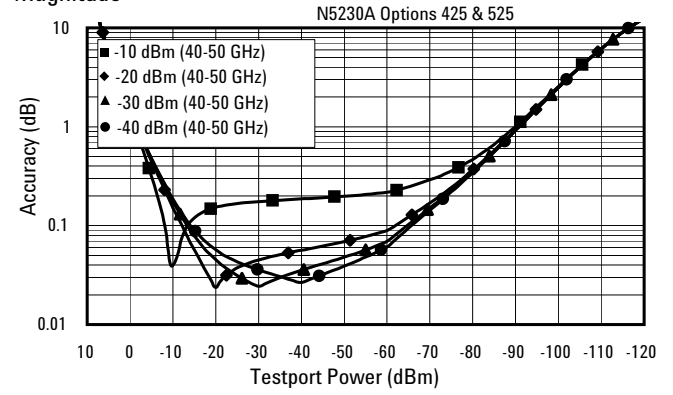

Phase

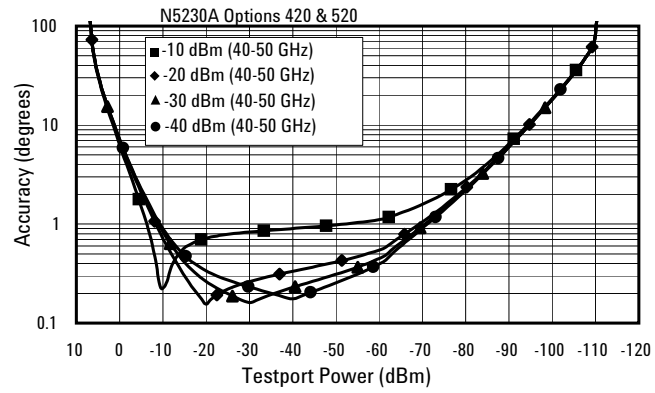

Phase

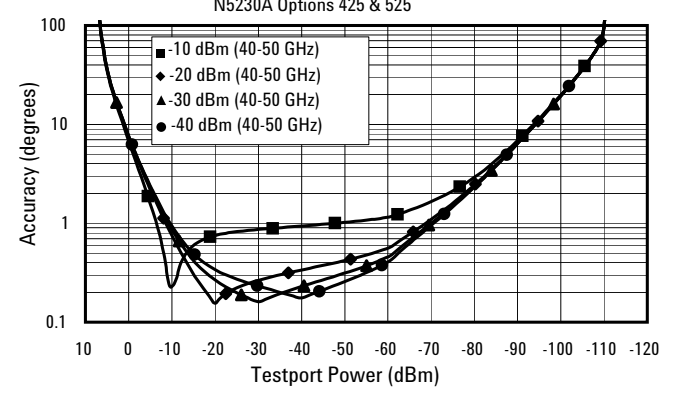
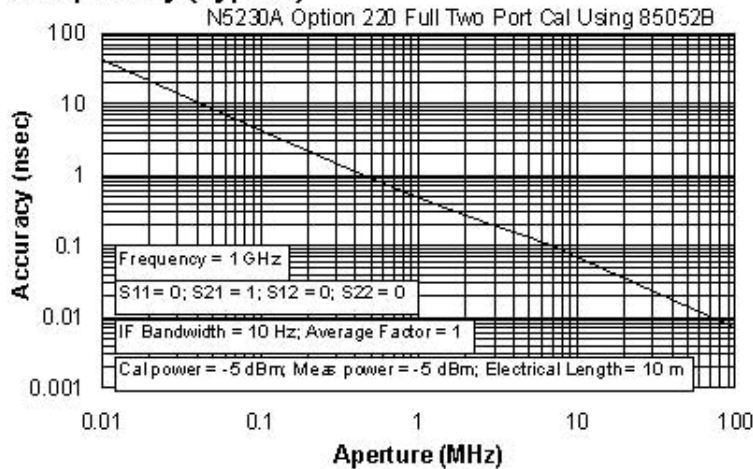

Table 10. Test port input (group delay)<sup>1</sup>

Description	Specification	Supplemental information (typ.)
Aperture (selectable)		(frequency span)/(number of points -1)
Maximum aperture		20% of frequency span
Range		0.5 x (1/minimum aperture)
Maximum delay		Limited to measuring no more than 180° of phase change within the minimum aperture
Accuracy		See graph below. Char.

The following graph shows characteristic group delay accuracy with full 2-port calibration and a 10 Hz IF bandwidth. Insertion loss is assumed to be < 2 dB and electrical length to be ten meters.

### Group Delay (Typical)



In general, the following formula can be used to determine the accuracy, in seconds, of specific group delay measurement:

$$\pm \text{Phase Accuracy (deg)} / [360^\circ \text{ Aperture (Hz)}]$$

Depending on the aperture and device length, the phase accuracy used is either incremental phase accuracy or worst case phase accuracy.

1. Group delay is computed by measuring the phase change within a specified frequency step (determined by the frequency span and the number of points per sweep).



## General Information

Table 11. Miscellaneous information

Description	Specification	Supplemental information
System IF bandwidth range		1 Hz to 250 kHz, nominal
CPU		Intel® 500 MHz Pentium® III

Table 12. Front panel information

Description	Supplemental information
<b>RF connectors</b>	
<b>N5230A</b>	
Type	Option 220 or 225: 3.5 mm (male), 50 ohm, (nominal) Option 420, 425, 520, or 525: 2.4 mm (male), 50 ohm, (nominal)
Center pin recession	0.002 in. (characteristic)
<b>Display</b>	
Size	21.3 cm (8.4 in) diagonal color active matrix LCD; 640 (horizontal) X 480 (vertical) resolution
Refresh rate	Vertical 59.83 Hz; Horizontal 31.41 kHz
<b>Display range</b>	
Magnitude	±500 dB (at 20 dB/div), max
Phase	±500°, max
Polar	10 pUnits, min 1000 Units, max
<b>Display resolution</b>	
Magnitude	0.001 dB/div, min
Phase	0.01°/div, min
<b>Marker resolution</b>	
Magnitude	0.001 dB, min
Phase	0.01°, min
Polar	0.01 mUnit, min; 0.01°,min

**Table 13. Rear panel information**

<b>Description</b>	<b>Supplemental information</b>
<b>10 MHz Reference in</b>	
Connector	BNC, female
Input frequency	10 MHz $\pm$ 10 ppm, typical
Input level	-15 dBm to +20 dBm, typical
Input impedance	200 W, nom.
<b>10 MHz Reference out</b>	
Connector	BNC, female
Output frequency	10 MHz $\pm$ 1 ppm, typical
Signal type	Sine Wave, typical
Output level	+10 dBm $\pm$ 4 dB into 50 W, typical
Output impedance	50 W, nominal
Harmonics	< -40 dBc, typical
<b>VGA Video output</b>	
Connector	15-pin mini D-Sub; Drives VGA compatible monitors
Devices supported:	
	<b>Resolutions:</b>
Flat panel (TFT)	1024 X 768, 800 X 600, 640 X 480
Flat panel (DSTN)	800 X 600, 640 X 480
CRT monitor	1280 X 1024, 1024 X 768, 800 X 600, 640 X 480
	Simultaneous operation of the internal and external displays is allowed, but with 640 X 480 resolution only. If you change resolution, you can only view the external display (internal display will "white out").
<b>Test set IO</b>	
	25-pin D-Sub connector, available for external test set control
<b>Aux IO</b>	
	25-pin D-Sub connector, male, analog and digital IO
<b>Handler IO</b>	
	36-pin parallel I/O port; all input/output signals are default set to negative logic; can be reset to positive logic via GPIB command
<b>GPIB</b>	
	24-pin D-sub (Type D-24), female; compatible with IEEE-488.
<b>Parallel port (LPT1)</b>	
	25-pin D-Sub miniature connector, female; provides connection to printers or any other parallel port peripherals
<b>Serial Port (COM 1)</b>	
	9-pin D-Sub, male; compatible with RS-232
<b>USB Port</b>	
	One port on front panel and five ports on rear panel. Universal Serial Bus jack, Type A configuration (4 contacts inline, contact 1 on left); female
Contact 1	Vcc: 4.75 to 5.25 VDC, 500 mA, maximum
Contact 2	-Data
Contact 3	+Data
Contact 4	Ground
<b>LAN</b>	
	10/100BaseT Ethernet, 8-pin configuration; auto selects between the two data rates

**Table 13. Rear panel information** (continued)

<b>Description</b>	<b>Supplemental information</b>
<b>Line power<sup>1</sup></b>	
Frequency	48 Hz to 66 Hz
Voltage at 115 V setting	90 to 132 VAC; 120 VAC, nominal
Voltage at 220 V setting	198 to 264 VAC; 240 VAC, nominal
VA Max	600 VA maximum

1. A third-wire ground is required.

**Note:** Option H08 and Option H11 specifications are not provided in this N5230A specifications document.

**Table 14. Analyzer environment and dimensions**

<b>Description</b>	<b>Supplemental information</b>
<b>General environmental</b>	
RFI/EMI susceptibility	Defined by CISPR Pub. 11, Group 1, Class A, and IEC 50082-1
ESD	Minimize using static-safe work procedures and an antistatic bench mat
Dust	Minimize for optimum reliability
<b>Operating environment</b>	
Temperature	0 °C to +40 °C Instrument powers up and displays no error messages within this temperature range (except for "source unlevelled" error message that may occur at temperatures outside the specified performance temperature range of 25 ± 5 °C).
Error-corrected temperature range	23 °C ± 3 °C with less than 1 °C deviation from calibration temp.
Humidity	5% to 95% at +40 °C
Altitude	0 to 4500 m (14,760 ft.)
<b>Non-operating storage environment</b>	
Temperature	-40 °C to +70 °C
Humidity	0% to 90% at +65 °C (non-condensing)
Altitude	0 to 15,240 m (50,000 ft.)
<b>Cabinet dimensions</b>	
	<b>Height    Width    Depth</b>
Excluding front and rear panel hardware and feet	267 mm    426 mm    427 mm 10.5 in    16.75    16.8 in
As shipped - includes front panel connectors, rear panel bumpers, and feet.	280 mm    435 mm    470 mm 11 in    17.10 in    18.5 in
As shipped plus handles	280 mm    458 mm    501 mm 11 in    18 in    19.7 in
As shipped plus rack-mount flanges	280 mm    483 mm    470 mm 11 in    19 in    18.5 in
As shipped plus handles and rack-mount flanges	280 mm    483 mm    501 mm 11 in    19 in    19.7 in
<b>Weight</b>	
Net	
N5230A	24.9 kg (55 lb), nominal
Shipping	
N5230A	36.3 kg (80 lb), nominal

# Measurement Throughput Summary

Table 15. Typical cycle time<sup>1,2</sup> (ms) for measurement completion

	Number of Points				
	201	401	801	1601	16,001
<b>Start 8 GHz, stop 18 GHz, 30 kHz IF bandwidth</b>					
Uncorrected	97.5	102.7	103.8	108.2	683.9
2-Port cal	203.7	213.5	218.5	234.6	1504.3
<b>Start 10 MHz, stop 10 GHz, 30 kHz IF bandwidth</b>					
Uncorrected	112.6	120.6	124.8	138.2	738.4
2-Port cal	232.8	251.8	265.2	304.3	1623.4
<b>Start 10 MHz, stop 20 GHz, 30 kHz IF bandwidth</b>					
Uncorrected	146	199.3	210.9	217.2	753.9
2-Port cal	302.3	410.5	438.7	462.5	1660.5
<b>Start 8 GHz, stop 18 GHz, 50 kHz IF bandwidth</b>					
Uncorrected	79.1	81	81.7	86.6	482
2-Port cal	164.5	170.3	175.3	193.5	1104.7
<b>Start 10 MHz, stop 10 GHz, 50 kHz IF bandwidth</b>					
Uncorrected	96.8	101.7	108.8	122.2	524.6
2-Port cal	202.1	215.6	236.7	276.7	1198.8
<b>Start 10 MHz, stop 20 GHz, 50 kHz IF bandwidth</b>					
Uncorrected	141.6	163.9	170.7	179.7	546.5
2-Port cal	293.6	341	360	389.5	1248.8

- 
1. Typical performance.
  2. Includes sweep time, retrace time and band-crossing time. Analyzer display turned off with DISPLAY:ENABLE OFF. Add 21 ms for display on. Data for one trace (S11) measurement.

**Table 16. Cycle Time vs IF Bandwidth<sup>1</sup>**

Applies to the preset condition (201 points, correction off) except for the following changes:

- CF = 10 GHz
- Span = 100 MHz
- Display off (add 21 ms for display on)

<b>IF Bandwidth (Hz)</b>	<b>Cycle time (ms)<sup>3</sup></b>	<b>Cycle time (ms) Option 080 enabled</b>
250,000	8.9	37.9
200,000	9.3	39.3
150,000	9.9	40.1
100,000	10.5	41.8
70,000	11.5	43.6
50,000	12.8	45.4
30,000	15.4	50
20,000	18.3	53.9
15,000	21	57.5
10,000	27	65.8
7000	34	75.4
5000	48.5	93
3000	72.8	124
2000	108.8	169
1500	126.8	187.1
1000	272.5	
700	357.7	
500	460	
300	697.7	
200	1003.5	
150	1307.8	
100	1917.6	
30	6173.8	
10	18214.8	
1	181699.2	

- 
1. Typical performance.
  2. Cycle time includes sweep and retrace time.

**Table 17. Cycle time vs number of points<sup>1</sup>**

Applies to the preset condition (correction off) except for the following changes:

- CF = 10 GHz
- Span = 100 MHz
- Display off (add 21 ms for display on)

IF Bandwidth (Hz)	Number of points	Cycle time (ms) <sup>2</sup>
30,000	3	8
	11	8
	51	9.38
	101	11.4
	201	15.5
	401	23.6
	801	39.9
	1,601	71.6
	6,401	265.4
	16,001	650.8
50,000	3	7.7
	11	7.7
	51	8.7
	101	10.1
	201	13
	401	18.6
	801	29.8
	1,601	52.3
	6,401	184.5
	16,001	448.8
250,000	101	8.7
	201	9.05
	401	10.85
	801	14.42
	1,601	21.63
	6,401	61.1
16,001	147.7	

**Table 18. Data transfer time (ms)<sup>1</sup>**

	Number of points			
	201	401	1601	16,001
<b>SCPI over GPIB (program executed on external PC)</b>				
32-bit floating point	7	12	43	435
64-bit floating point	12	22	84	856
ASCII	64	124	489	5054
<b>SCPI (program executed in the analyzer)</b>				
32-bit floating point	1	2	3	30
64-bit floating point	2	2	4	40
ASCII	29	56	222	2220
<b>COM (program executed in the analyzer)</b>				
32-bit floating point	< 0.4	0.4	0.5	1.9
Variant type	0.7	1	3	32
<b>DCOM over LAN (program executed on external PC)</b>				
32-bit floating point	< 0.8	1	1.5	7.1
Variant type	1.8	2.7	8.5	80

1. Typical performance.

2. Cycle time includes sweep and retrace time.

**Note:** Specifications for recall and sweep speed are not provided for the N5230A analyzers.

# Specifications: Front-Panel Jumpers

## Model N5230A Option 225, or 425, or 525

**Note:** The N5230A Option 220, or 420, or 520 (standard test set and standard power range) has no front-panel jumpers.

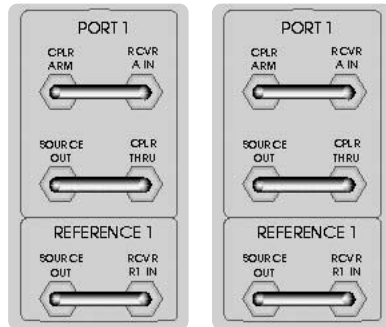

**Table 19: Measurement receiver inputs (rcvr A In, rcvr B In)  
0-1 dB Typical Compression**

Description	Specification	Typicals	
		Option 225	Options 425, 525
<b>Maximum input level</b>			
10 MHz to 45 MHz		-2 dBm	-20 dBm
45 MHz to 500 MHz		-2 dBm	-19 dBm
500 MHz to 2 GHz		-3 dBm	-14 dBm
2 GHz to 8 GHz		-6 dBm	-14 dBm
8 GHz to 12.5 GHz		-6 dBm	-14 dBm
12.5 GHz to 20 GHz		-6 dBm	-15 dBm
20 GHz to 30 GHz			-16 dBm
30 GHz to 40 GHz			-21 dBm
40 GHz to 45 GHz			-24 dBm
45 GHz to 50 GHz			-22 dBm
<b>Damage level</b>			
N5250A		+15 dBm	+15 dBm
<b>Maximum DC level</b>			
N5250A		±7 V	±7 V

**Table 20: Reference receiver inputs (rcvr R1, rcvr R2)  
at maximum specified output power**

Description	Specification	Typicals	
		Option 225	Options 425, 525
<b>Maximum input level</b>			
10 MHz to 45 MHz		-18 dBm	-28 dBm
45 MHz to 500 MHz		-18 dBm	-28 dBm
500 MHz to 2 GHz		-18 dBm	-28 dBm
2 GHz to 8 GHz		-19 dBm	-28 dBm
8 GHz to 12.5 GHz		-21 dBm	-27 dBm
12.5 GHz to 20 GHz		-23 dBm	-26 dBm
20 GHz to 30 GHz			-33 dBm
30 GHz to 40 GHz			-27 dBm
40 GHz to 45 GHz			-29 dBm
45 GHz to 50 GHz			-28 dBm
<b>Damage level</b>			
N5250A		+15 dBm	+15 dBm
<b>Maximum DC level</b>			
N5250A		±7 V	±7 V

**Table 21: Reference Outputs (reference 1 source out, reference 2 source out)  
at maximum specified output power**

Description	Specification	Typicals	
		Option 225	Options 425, 525
<b>Maximum output level</b>			
10 MHz to 45 MHz		-18 dBm	-28 dBm
45 MHz to 500 MHz		-18 dBm	-28 dBm
500 MHz to 2 GHz		-18 dBm	-28 dBm
2 GHz to 8 GHz		-19 dBm	-28 dBm
8 GHz to 12.5 GHz		-20 dBm	-27 dBm
12.5 GHz to 20 GHz		-23 dBm	-26 dBm
24 GHz to 30 GHz			-32 dBm
30 GHz to 40 GHz			-26 dBm
40 GHz to 45 GHz			-29 dBm
45 GHz to 50 GHz			-28 dBm
<b>Damage level</b>			
N5250A		+20 dBm	+20 dBm
<b>Maximum DC level</b>			
N5250A		±7 V	±7 V

**Table 22: Source outputs (port 1 source out, port 2 source out)  
at maximum specified output power**

Description	Specification	Typicals	
		Option 225	Options 425, 525
<b>Maximum output level</b>			
10 MHz to 45 MHz		6 dBm	+1 dBm
45 MHz to 500 MHz		+6 dBm	+1 dBm
500 MHz to 2 GHz		+7 dBm	+1 dBm
2 GHz to 8 GHz		+7 dBm	+1 dBm
8 GHz to 12.5 GHz		+7 dBm	+1 dBm
12.5 GHz to 20 GHz		+5 dBm	+3 dBm
24 GHz to 30 GHz			-5 dBm
30 GHz to 40 GHz			-4 dBm
40 GHz to 45 GHz			-11 dBm
45 GHz to 50 GHz			-11 dBm
<b>Damage level</b>			
N5250A		30 dBm	30 dBm
<b>Maximum DC level</b>			
N5250A		±7 V	±7 V



**Table 23: Coupler inputs (port 1 Cplr Thru, port 2 Cplr Thru)**

Description	Specification	Typicals	
		Option 225	Options 425, 525
<b>Insertion loss to test port</b>			
10 MHz to 45 MHz		0.6 dB	0.6 dB
45 MHz to 500 MHz		0.6 dB	0.6 dB
500 MHz to 2 GHz		1.6 dB	0.8 dB
2 GHz to 8 GHz		1.8 dB	1.0 dB
8 GHz to 12.5 GHz		1.9 dB	1.0 dB
12.5 GHz to 20 GHz		2.0 dB	2.0 dB
20 GHz to 30 GHz			3.0 dB
30 GHz to 40 GHz			4.0 dB
40 GHz to 45 GHz			4.0 dB
45 GHz to 50 GHz			4.0 dB
<b>Damage level</b>			
N5250A		+30 dBm	+30 dBm
<b>Maximum DC level</b>			
N5250A		±40 V	±40 V

**Table 24: Coupler outputs (port 1 Cplr Arm, port 2 Cplr Arm)**

Description	Specification	Typicals	
		Option 225	Options 425, 525
<b>Damage level</b>			
N5250A		+30 dBm	+30 dBm
<b>Maximum DC level</b>			
N5250A		±7 V	±7 V

## Test Set Block Diagrams

### N5230A Option 220, or 420, or 520

(standard test set and standard power range) network analyzer

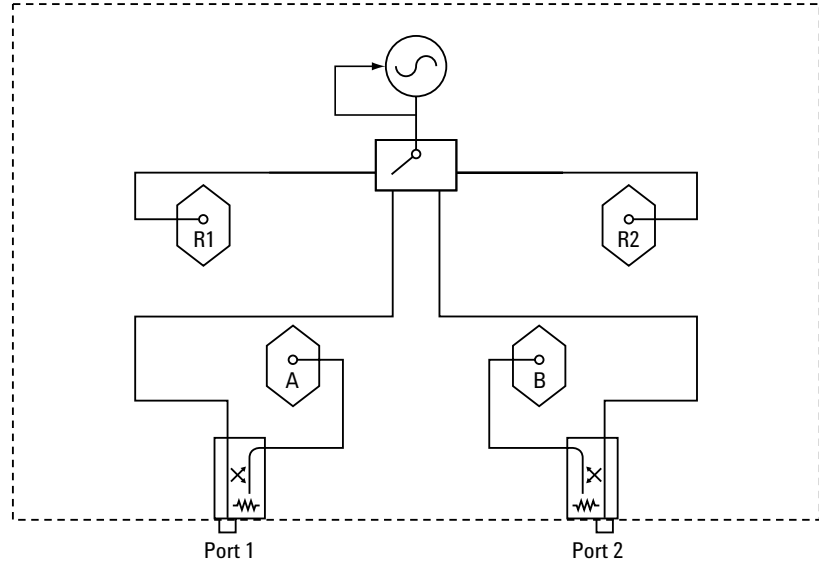

### N5230A Option 225, or 425, or 525

(configurable test set and extended power range) network analyzer

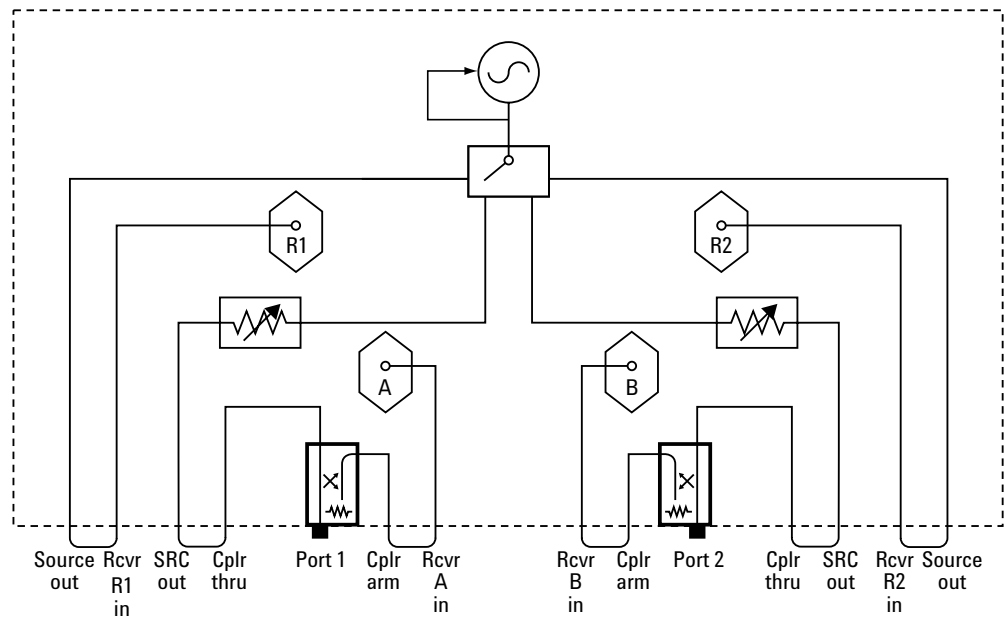

## Web Resources

Visit our Web sites for additional product information and literature.

PNA Microwave network analyzers:  
**[www.agilent.com/find/pna](http://www.agilent.com/find/pna)**

PNA-L network analyzers:  
**[www.agilent.com/find/pnal](http://www.agilent.com/find/pnal)**

Electronic calibration (ECal):  
**[www.agilent.com/find/ecal](http://www.agilent.com/find/ecal)**

Test and measurement solutions:  
**[www.agilent.com/find/accessories](http://www.agilent.com/find/accessories)**

**Agilent Technologies' Test and Measurement Support, Services, and Assistance**

Agilent Technologies aims to maximize the value you receive, while minimizing your risk and problems. We strive to ensure that you get the test and measurement capabilities you paid for and obtain the support you need. Our extensive support resources and services can help you choose the right Agilent products for your applications and apply them successfully. Every instrument and system we sell has a global warranty. Support is available for at least five years beyond the production life of the product. Two concepts underlie Agilent's overall support policy: "Our Promise" and "Your Advantage."

**Our Promise**

Our Promise means your Agilent test and measurement equipment will meet its advertised performance and functionality. When you are choosing new equipment, we will help you with product information, including realistic performance specifications and practical recommendations from experienced test engineers. When you receive your new Agilent equipment, we can help verify that it works properly and help with initial product operation.

**Your Advantage**

Your Advantage means that Agilent offers a wide range of additional expert test and measurement services, which you can purchase according to your unique technical and business needs. Solve problems efficiently and gain a competitive edge by contracting with us for calibration, extra-cost upgrades, out-of-warranty repairs, and onsite education and training, as well as design, system integration, project management, and other professional engineering services. Experienced Agilent engineers and technicians worldwide can help you maximize your productivity, optimize the return on investment of your Agilent instruments and systems, and obtain dependable measurement accuracy for the life of those products.

**Agilent T&M Software and Connectivity**

Agilent's Test and Measurement software and connectivity products, solutions and developer network allows you to take time out of connecting your instruments to your computer with tools based on PC standards, so you can focus on your tasks, not on your connections. Visit [www.agilent.com/find/connectivity](http://www.agilent.com/find/connectivity) for more information.

**For more information on Agilent Technologies' products, applications or services, please contact your local Agilent office. The complete list is available at:**

[www.agilent.com/find/contactus](http://www.agilent.com/find/contactus)

**Phone or Fax**

**United States:**

(tel) 800 829 4444  
(fax) 800 829 4433

**Canada:**

(tel) 877 894 4414  
(fax) 800 746 4866

**China:**

(tel) 800 810 0189  
(fax) 800 820 2816

**Europe:**

(tel) 31 20 547 2111

**Japan:**

(tel) (81) 426 56 7832  
(fax) (81) 426 56 7840

**Korea:**

(tel) (080) 769 0800  
(fax) (080)769 0900

**Latin America:**

(tel) (305) 269 7500

**Taiwan:**

(tel) 0800 047 866

(fax) 0800 286 331

**Other Asia Pacific Countries:**

(tel) (65) 6375 8100

(fax) (65) 6755 0042

Email: [tm\\_ap@agilent.com](mailto:tm_ap@agilent.com)

Contacts revised: 9/17/04



**Agilent Email Updates**

[www.agilent.com/find/emailupdates](http://www.agilent.com/find/emailupdates)  
Get the latest information on the products and applications you select.

Intel® and Pentium® are US registered trademarks of Intel Corporation.

Product specifications and descriptions in this document subject to change without notice.

© Agilent Technologies, Inc. 2003, 2004  
Printed in USA, October 6, 2004  
5989-0514EN



**Agilent Technologies**